



Grupo  
**FYCE**



**Almacén de Fontanería**

# **TARIFA AGENDA 2024**

*Siempre Cerca de tí*



# ÍNDICE

## Fontanería

### PVC EVACUACIÓN Y Presión 1 - 10

Accesorios PVC Evacuación - Presión  
Insonorizado  
Tuberías (Evacuación, Presión)  
Adhesivos  
Hidrotubo  
Canaleta de Suelo y Arquetas  
Canal PVC (Tuberías y Accesorios)

### COBRE 11 - 13

Accesorios, Tubería, Soldadura, Foncal y  
Accs, Compresión

### INOXIDABLE 15 - 16

Tubería y Accesorio

### LATÓN 17 - 19

Roscar y Soldar-Roscar

### MULTICAPA ISOLTUBEX 21 - 22

Prensado

### POLIET RETICUL PERT 23 - 24

Prensado

### MULTICAPA 25 - 26

STH y Compresión

### POLIETILENO RETICULADO 27 - 28

"PEX" (ISOLTUBEX)

### POLIPROPILENO 29 - 30

(PPR) Accesorio y tubería

### POLIETILENO 31 - 32

Accesorios latón, plásticos y tuberías

### POLIETILENO ELECTROSOLDABLE 33

### POLIBUTILENO 35 - 36

Accesorios y Tubería

### HIERRO 37 - 40

Accesorios, Tubería y Gebo

### FIJACIÓN, SELLANTES, CLAVADO Y PERFORACIÓN 41 - 44

### VARIOS DE FONTANERÍA 45 - 46

### CONEXIONES Y RIVER INOX 47

### MECANISMOS WC 49 - 50

**ARCO** 51 - 53

Valvulería (Agua y Gas)

**JIMTEN** 55 - 57

**BATERÍAS DE CONTADOR Y  
COMPLEMENTOS** 59 - 60

**BOMBAS,  
GRUPOS DE PRESIÓN** 61 - 64

**HERRAMIENTAS  
Y SEGURIDAD LABORAL** 65 - 70

## Tratamientos de Aguas

**TRATAMIENTOS DE AGUA** 71 - 76

Descalcificación, Osmosis, Fosas Sépticas  
y Complementos

## Calefacción

**AEROTERMIA** 79 - 80

**SUELO RADIANTE** 81 - 83

**RADIADORES DE ALUMINIO,  
VALVULERÍA Y ACCESORIOS  
DE RADIADOR** 84

**PROGRAMACIÓN  
Y TOALLEROS** 85

**AISLAMIENTO** 86

**CALDERAS  
Y COMPLEMENTOS** 87 - 89

**SENTINEL** 90

## ACS (Agua Caliente)

**CALENTADORES VAILLANT** 91

**CALENTADORES ARISTON Y  
CONDUCTOS** 92

**TEMOS ELÉCTRICOS** 93 - 94

**AEROTERMIA Y SOLAR  
(TERMOSIFONES)** 95

# Climatización

SPLITS MURALES, CASSETES, CONDUCTOS, FANCOILS Y COMPLEMENTOS

97 - 100

## Piscinas y Riego

DEPURACIÓN Y  
ELECTRÓLISIS SALINA

101

RIEGO

104

ACCESORIOS VASO  
PISCINA, ILUMINACIÓN,  
LIMPIEZA

102-103

## Ventilación Mecánica

SIMPLE FLUJO

105-106

DOBLE FLUJO

107

## Gas

GAS BUTANO Y NATURAL

109

GAS MULTICAPA

110

Tubería y Accesorios

# Baños











SERIE PORCELANA ROCA	111
RESPUESTOS ROCA	112-113
COMPLEMENTOS WC SOLFLESS	113-114
SERIES PORCELANA UNISAN	115-116
COMPLEMENTOS UNISAN	117
SERIES SUSPENDIDAS	118
CISTERNAS EMPOTRADAS	119
ASIENTOS WC Y DUCHAS HIGIÉNICAS	120

# Cocinas

FREGADEROS	145-148
GRIFERÍA COCINA	149-150









COLECTIVIDADES	121
ACCESORIOS Y COMPLEMENTOS BAÑO	122
PLATOS DE DUCHA Y CANALETAS	123-125
MAMPARAS	127-131
DUCHAS Y COMPLEMENTOS	133-135
MUEBLES	137-138
GRIFERIAS	139-144

## P.V.C. - EVACUACIÓN

Ø	REF.		REF.	REF.	
45° □ €			45° □ €		
	32 H-H 0232903245			32 H-H 0232133245	50 0,85
	32 M-H 0232920324	120 0,55		40 H-H 0232134045	55 0,96
	40 H-H 0232904045			50 H-H 0232135045	40 3,54
	40 M-H 0232920404	80 0,65		75 M-H 0232130754	40 4,10
	50 H-H 0232905045			90 M-H 0232130904	25 4,20
	50 M-H 0232920504	85 1,67		110 M-H 0232131104	20 4,29
	75 M-H 0232920754	50 2,25		125 M-H 0232131254	16 7,69
	90 M-H 0232920904	90 1,95		160 M-H 0232131604	6 16,31
	110 M-H 0232921104	60 2,16		200 M-H 0232132004	3 42,54
	125 M-H 0232921254	44 3,19		250 M-H 0232132504	1 80,89
	160 M-H 0232921604	18 6,39		315 M-H 0232133154	1 214,03
	200 M-H 0232922004	8 16,93			
	250 M-H 0232922504	4 27,54			
	315 M-H 0232923154	1 109,11			
67° □ €			67° □ €		
	32 H-H 0232903267	90 0,64		32 H-H 0232133267	60 0,98
	32 M-H 0232920326	100 1,99		40 H-H 0232134067	60 1,90
	40 H-H 0232904067	120 0,65		50 H-H 0232135067	10 3,47
	40 M-H 0232920406	120 2,09		75 M-H 0232130756	50 6,56
	50 H-H 0232905067	70 2,03		90 M-H 0232130906	35 8,00
	50 M-H 0232920506	70 2,19		110 M-H 0232131106	20 8,82
	75 M-H 0232920756	40 2,39		125 M-H 0232131256	15 13,08
	90 M-H 0232920906	25 3,15		160 M-H 0232131606	7 35,50
	110 M-H 0232921106	35 3,47			
	125 M-H 0232921256	25 5,42			
	160 M-H 0232921606	12 16,75			
87° □ €			87° □ €		
	32 H-H 0232903287	100 0,37		32 H-H 0232133287	60 0,88
	32 M-H 0232920328	100 0,72		40 H-H 0232134087	70 0,96
	40 H-H 0232904087	110 0,38		50 H-H 0232135087	45 2,58
	40 M-H 0232920408	110 0,76		75 M-H 0232130758	50 3,35
	50 H-H 0232905087	65 0,96		90 M-H 0232130908	30 3,50
	50 M-H 0232920508	75 1,65		110 M-H 0232131108	25 3,61
	75 M-H 0232920758	40 1,82		125 M-H 0232131258	15 6,15
	90 M-H 0232920908	65 1,91		160 M-H 0232131608	8 11,06
	110 M-H 0232921108	45 1,96		200 M-H 0232132008	4 43,74
	125 M-H 0232921258	30 4,05		250 M-H 0232132508	2 116,36
	160 M-H 0232921608	15 7,97		315 M-H 0232133158	1 227,39
	200 M-H 0232922008	6 25,10			
	250 M-H 0232922508	3 46,35			
	315 M-H 0232923158	1 144,68			
	110 0232181104	12,81		110 0232221104	70,45
	125 0232181254	25,24		125 0232221254	86,35
	160 0232181604	73,10			
	110 0232181106	19,64		110 0232221106	78,59
	125 0232181256	24,38		125 0232221256	95,07
	110 0232181108	16,55		110 0232221108	74,33
	125 0232181258	25,41		125 0232221258	91,09
	160 0232181608	68,87			

D. D. ANGULAR

## P.V.C. - EVACUACIÓN

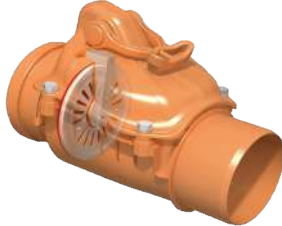
Ø	REF.	REF.	REF.
	* PUNTO DE REGISTRO	<b>991301998</b>	<b>10,19</b>
	110.125.40	<b>0232111240</b>	<b>1,79</b>
	110.125.50	<b>0232111250</b>	<b>1,89</b>
	75.50	<b>0232000250</b>	<b>21,89</b>
	90.50	<b>0232000260</b>	<b>21,94</b>
	110.90	<b>0232000299</b>	<b>29,52</b>
	125.110	<b>0232000829</b>	<b>36,29</b>
	160.50	<b>0232000825</b>	<b>34,40</b>
	160.110	<b>0232000830</b>	<b>37,12</b>
	160.125	<b>0232000832</b>	<b>69,02</b>
	200.110	<b>0232000831</b>	<b>49,06</b>
	200.125	<b>0232000834</b>	<b>63,91</b>
	200.160	<b>0232000838</b>	<b>61,60</b>
	15 26.30.32	<b>0232263032</b>	<b>3,50</b>
	15 30.34.32	<b>0232303432</b>	<b>3,81</b>
	25 34.38.40	<b>0232343840</b>	<b>5,70</b>
	110		
	<b>460132036</b>		<b>64,52</b>
	125		
	<b>460132037</b>		<b>84,59</b>
	*160		
	<b>0232000060</b>		<b>95,87</b>
	20 x 20	<b>991394102</b>	<b>5,92</b>
	30 x 30	<b>991394103</b>	<b>13,87</b>
	40 x 40	<b>991394104</b>	<b>32,43</b>
	55 x 55	<b>991394105</b>	<b>78,37</b>
	20 x 20	<b>991394106</b>	<b>12,52</b>
	30 x 30	<b>991394109</b>	<b>26,28</b>
	40 x 40	<b>991394107</b>	<b>46,00</b>
	55 x 55	<b>991394110</b>	<b>96,06</b>
	20 x 20	<b>991394115</b>	<b>6,06</b>
	30 x 30	<b>991394116</b>	<b>8,59</b>
	40 x 40	<b>991394117</b>	<b>11,40</b>
	55 x 55	<b>991394118</b>	<b>20,95</b>
	50	<b>1234</b>	<b>53,57</b>
	75	<b>1560</b>	<b>63,16</b>
	110	<b>991301235</b>	<b>82,59</b>
	125	<b>991301236</b>	<b>103,88</b>
	160	<b>991301237</b>	<b>114,45</b>
	200	<b>1238</b>	<b>239,86</b>
	250	<b>1239</b>	<b>570,29</b>
	315	<b>1280</b>	<b>799,64</b>





C-80  
BOOK









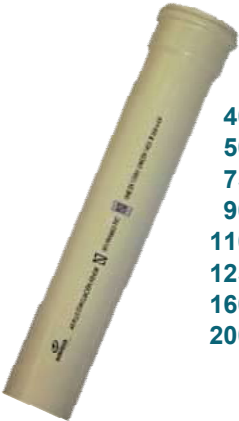

# Solución C-80

Portarrollo  
con llave de escuadra



Montaje **vertical** u **horizontal**

P.V.C. - EVACUACIÓN INSONORIZADO

MEDIDA	REF.	□	€	MEDIDA	□	REF.	€
	40x5	624540500					35,66
	50x5	624550500					40,51
	75x3	624575300					37,80
	90x3	624590300					50,86
	110x3	624511030					56,50
	125x3	624512530					79,69
	160x3	624516030					105,34
200x3	624520030					172,21	
	90x67	0245929067	25				10,15
	110x67	0245921106	35				10,91
	125x67	0245921256	25				15,32
	75x87	0245927587	10				6,69
	90x87	0245929087	20				8,84
	M-H 40x45	0245924045	30				2,05
	40x45	0245904045	30				2,46
	50x45	0245905045	20				3,40
	110x87	0245921108	30				9,01
	125x87	0245921258	20				16,43
	160x87	0245921608	8				32,56
	200x87	0245922008	6				59,43
	250x87	0245922508	3				96,80
	40x67	0245904067	30				3,75
		40	0245270040	30			
50		0245270050	25				3,42
	M-H 40x87	0245924087	30				2,56
	40x87	0245904087	30				2,55
	50x87	0245905087	15				3,83
	75	0245272075	20				5,54
	90	0245272090	40				8,86
	110	0245272110	55				10,02
	125	0245272125	35				13,23
	160	0245272160	8				24,46
	200	0245272200	4				41,21
	75x45	0245927545	15				5,85
	90x45	0245929045	30				7,37
	110x45	0245921104	40				7,70
	125x45	0245921254	25				12,35
	160x45	0245921604	15				23,45
	200x45	0245920004	8				47,65
		90x110	0245090110	25			
90x125		0245090125	20				13,99
110x125		0245110125	10				14,23
110x160		0245110160	15				22,88
125x160		0245125160	15				25,12
200x125		0245200125	5				30,82
200x160		0245200160	6				38,47

## P.V.C. - EVACUACIÓN INSONORIZADO

MEDIDA □ REF. €				MEDIDA REF. □ €							
	40x45	0245134045	50	6,58		110/125x40	0245200174	35	8,21		
	50x45	0245135045	40	7,91		110/125x50	0245200175	35	8,22		
	40x87	0245134085	65	5,30		50	0245300500	30	3,15		
	50x87	0245135087	40	6,37		75	0245300750	15	4,32		
	75x45	0245200143	12	12,73		90	0245300900	30	6,78		
	90x45	0245200182	25	16,69		110	0245300110	35	8,05		
	110x45	0245131104	15	17,62		125	0245300125	25	11,12		
	125x45	0245131254	12	31,23		160	0245300160	15	14,32		
	160x45	0245200189	6	45,32		200	0245300200	10	24,35		
200x45	0245200191	3	99,34								
	75x87	0245200145	8	11,48		50x40	0245122116	30	4,05		
	90x87	0245200180	15	16,69		75x40	0245007540	15	2,75		
	110x87	0245131108	20	17,62		90x40	0245009040	30	4,15		
	125x87	0245200161	15	25,43		75x50	0245007550	15	2,90		
	160x87	0245200188	8	54,36		90x50	0245009050	30	4,25		
200x87	0245200190	4	99,43	110x40		0245110400	35	5,15			
	110x45	0245181104	12	51,11		110x50	0245110500	35	5,25		
	125x45	0245181254	10	72,34		110x75	0245110750	15	5,35		
		110x87	0245200192	15		51,11	125x50	0245125500	25	6,05	
		125x87	0245200186	10		72,34					
	110x40x40	0245110404	40	10,54		110x40x40	0245110404	40	10,54		
	110x40x40x40	0245114040	55	10,01		110x40x40x40	0245114040	55	10,01		
						LUBRICANTE	040260750		7,53		

## P.V.C. - PRESIÓN

Ø					REF.			Ø			REF.			€	
	CODO HH				45°	€	90°	€							
	16	023645016	0,87	023690016	0,55										
	20	023645020	0,88	023690020	0,59										
	25	023645025	0,90	023690025	0,84										
	32	023645032	1,41	023690032	1,17										
	40	023645040	1,73	023690040	1,61										
	50	023645050	2,51	023690050	2,26										
	50 M-H			023690540	4,00										
	63	023645063	3,68	023690063	3,91										
	75	023245075	6,22	023690075	6,15										
90	023645090	9,59	023690090	10,17											
	M-H														
	CRUZ														
	16		023613016	1,63											
	20		023613020	0,74											
	25		023613025	0,88											
	32		023613032	1,44											
	40		023613040	2,13											
	50		023613050	3,45											
	TE IGUAL H														
	50 CRUZ		023618050	9,57											
	63		023613063	4,20											
	75		023613075	8,42											
	90		023613090	15,39											
	TAPÓN H														
	25		023630025	0,56											
	32		023630032	0,78											
	40		023630040	1,46											
	50		023630050	1,83											
63		023630063	2,43												
	CASQUILLO REDUCTOR														
	20.16		023602016	0,50											
	25.20		023602520	0,51											
	32.25		023603225	0,56											
	40.20		023604020	0,91											
	40.25		023604025	0,92											
	40.32		023604032	0,82											
	50.40		023605040	1,04											
	63.50		023606350	1,44											
	75.63		023607563	2,34											
90.75		023609075	4,02												
	VÁLVULA ESFERA														
	20 ENCOLAR		461200020	10,21											
	25 ENCOLAR		461200025	12,23											
	32 ENCOLAR		461200032	18,36											
	40 ENCOLAR		461200040	20,44											
	50 ENCOLAR		461200050	25,43											
	63 ENCOLAR		461200063	37,19											
	75 ENCOLAR		461200075	200,97											
	90 ENCOLAR		461200090	221,18											
	1/2" ROSCA/H		461200012	10,21											
3/4" ROSCA/H		461200034	12,23												
1" ROSCA/H		461200001	18,36												
1 1/4" ROSCA/H		461200114	22,25												
1 1/2" ROSCA/H		461200112	31,66												
2" ROSCA/H		461200002	43,17												
	ENLACE DE REPARACIÓN														
	50 ENCOLAR		023736505	26,08											
	63 ENCOLAR		023736506	34,08											
50 ENCOLAR		461263350	7,45												
63 ENCOLAR		461263463	12,16												
	UNIÓN 3 PZAS.														
	25		460734025	2,41											
	32		460734032	3,43											
	40		460734040	4,13											
	50		460734050	5,05											
	63		460734063	7,37											
	50		023702331	5,48											
	63		023702332	8,06											
	50.1" 1/2		460734150	9,43											
	63.2		460734163	12,96											
	ENCOLAR-RM														

## P.V.C. - TUBERÍA GRIS



COLLARIN INTUMESCENTE

Ø mm	REF.	€
110	300222110	46,87
125	300222125	68,54
160	300222160	96,32



GLOBO CORTA AGUAS BAJANTE

Ø mm	REF.	€
110	991385110	30,95
125	991385125	32,59
160	991385160	42,70



Ø	LARGO	REF.	€/tubo
<b>SERIE B</b>			
32	5 mts.	621632500	19,44
40	5 mts.	621640500	22,96
50	5 mts.	621650500	28,95
75	5 mts.	621675500	43,97
90	5 mts.	621690500	52,82
110	5 mts.	621611050	68,32
125	5 mts.	621612550	78,15
160	5 mts.	621616050	104,32
200	5 mts.	621620050	156,73
250	5 mts.	621625050	212,00
315	5 mts.	621631504	149,30

110	1 mts.	621611010	28,37
125	1 mts.	621612510	35,08

75	3 mts.	621675300	26,45
90	3 mts.	621690300	31,76
110	3 mts.	621611030	41,05
125	3 mts.	621612530	46,96
160	3 mts.	621616030	62,74
200	3 mts.	621620030	94,28
250	3 mts.	621625030	121,87

ESTRUCTURADA			
90	3 mts.	621590300	24,83
110	3 mts.	621511030	31,86
125	3 mts.	621512530	37,43
160	3 mts.	621516030	48,80

Hidrotubo Blanco	27 x 32	620800132	8,59
Hidrotubo Blanco	35 x 40	620800140	11,40
Hidrotubo Gris	13 x 16	620800016	7,48
Hidrotubo Gris	16 x 20	620800020	8,50
Hidrotubo Gris	20 x 25	620800025	8,88
Hidrotubo Gris	27 x 32	620800032	8,59
Hidrotubo Gris	35 x 40	620800040	11,40
Hidrotubo Gris	43 x 50	620800050	19,15
Hidrotubo Gris	55 x 63	620800063	27,18



HIDROTUBO

\* Rollo 50 mts.

## P.V.C. - ADHESIVOS



ADHESIVO	Q	REF.	€	ADHESIVO	REF.	€	ADHESIVO	REF.	€
FYCE Bote 1Kg.	12	040401000	23,42	GRIFFON Extra Rapido 500 ml	040230207	16,46	COLLAK 1Kg.	040221100	19,40
FYCE Bote 500 grs.	24	040400500	13,55	GRIFFON PVC Bote C/Brocha 500ml	040232091	10,01	COLLAK 500grs.	040221500	11,15
FYCE Tubo 125 grs.	25	040400125	3,25	GRIFFON Extrarapido 250 ml	040237286	9,34	COLLAK 125grs.	040221125	3,17
Limpiador ½ litro	24	040420500	7,75				COLLAK 500grs. Flexible	040231500	12,12

## P.V.C. - POLIETILENO CORRUGADO SN-8



Ø	REF.	€/mts
160	622210160	8,28
200	622210200	10,81
250	622210250	17,32
315	622210315	24,45
400	622210400	39,61

## TUBERÍA LISA DE PRESIÓN



Ø mm.	LARGO	REF.	€/METRO
16 x 20 atm.	5 mts.	621820016	1,29
20 x 20 atm.	5 mts.	621820020	1,29
25 x 16 atm.	5 mts.	621816025	1,59
32 x 16 atm.	5 mts.	621816032	2,55
40 x 10 atm.	5 mts.	621810040	2,51
50 x 10 atm.	5 mts.	621810050	3,47
63 x 10 atm.	6 mts.	621810063	5,36
75 x 10 atm.	6 mts.	621810075	7,66
90 x 10 atm.	6 mts.	621810090	10,95

**CANALETA NARVIK – 1 (Polipropileno)  
CON REJILLA**

**Altura 7 cm**



- Dimensiones Externas: 1000 x 125 x 72 mm
- Dimensiones Internas: 1000 x 100 x 70 mm

**MODELOS REJILLA – NARVIK 1**

Referencia	Descripción	Resistencia	Ud / caja	€ / ud.
715000	Canaleta + Rejilla Acero Galvanizado	A-15	1	21,94
715001	Canaleta + Rejilla PE -HD Color Negro	A-15	1	15,99
715002	Canaleta + Rejilla PE -HD Color Gris	A-15	1	24,82
715112	Canaleta + Rejilla PE -HD Color Blanco	A-15	1	24,98
715003	Canaleta + Rejilla – Fundición Dúctil	A-15	1	45,06

**CANALETA NARVIK – 3 (Polipropileno)  
CON REJILLA**

**Altura 10 cm**



- Dimensiones Externas: 1000 x 125 x 100 mm
- Dimensiones Internas: 1000 x 100 x 85 mm













**MODELOS REJILLA – NARVIK 3**

Referencia	Descripción	Resistencia	Ud / caja	€ / ud.
715020	Canaleta + Rejilla Acero Galvanizado	A-15	1	28,57
715021	Canaleta + Rejilla PE -HD Color Negro	A-15	1	20,80
715022	Canaleta – Fundición Dúctil	A-15	1	52,16
715023	Canaleta – Fundición Dúctil	C-250	1	79,53

## P.V.C. - CANAL TRAPEZIAL BLANCA (DESARROLLO 260mm)

			Ø	REF.	€				REF.	€
			90	220190300	39,18				220126003	17,16
	long. 3 mts.									
			90	220127090	4,08				220126907	3,83
	BAJANTE MANGUITO									
			90 x 45	220104590	4,55				220126904	6,94
	CODO M-H									
			90 x 87	220108790	4,93				220126664	3,87
	CODO M-H									
			90	220110090	1,58				220126916	1,45
	COLLARIN									
				220126978	1,31				220126903	1,81
	GANCHO									

## P.V.C. - CANAL CIRCULAR GRIS

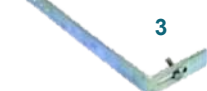
			Ø	REF.	€				Ø	REF.	€
			25	220625114	20,24				25	220609025	8,80
	long. 4 mts.		33	220633164	39,72				33	220629033	13,11
			25	220610025	5,90				25	220609925	1,30
	UNIÓN CANALON		33	220632033	8,40				33	220629933	2,80
			25	220609225	4,51				25	220609825	1,90
	BAJADA CENTRAL		33	220629233	12,86				33	220629833	2,24
			25	220609325	7,91				90-75	220634383	4,10
	BAJADA EXT. IZQDA		33	220629333	11,95				110-90	220634384	5,02
			25	220609425	8,03			(1)	220629533	1,85	
	BAJADA EXT. DRCHA		33	220629433	10,67			(2)	220629733	3,33	
			25	220609125	9,20			(3)	220629633	3,88	
	ANGULO INTERIOR		33	220629133	16,32						



## COBRE

□ MEDIDA REF. €/mtr.

□ MEDIDA REF. €



CODO 90°  
H-H 90 CU

10	10	021209010	2,16
25	12	021209012	0,74
10	15	021209015	0,74
10	18	021209018	1,10
10	22	021209022	1,82
10	28	021209028	3,03
	35	021209035	12,22
	42	021209042	20,02
	54	021209054	37,44



TE IGUAL  
HEMBRA 130 CU

10	10	021201310	3,25
10	12	021201312	1,36
25	15	021201315	1,17
10	18	021201318	2,32
10	22	021201322	3,47
10	28	021201328	6,33
10	35	021201335	18,38
	42	021201342	34,51
	54	021201354	57,52



CODO 90°  
M-H 92 CU

10	10	021209210	3,40
25	12	021209212	1,61
10	15	021209215	0,81
10	18	021209218	1,77
10	22	021209222	2,74
10	28	021209228	4,85
	35	021209235	19,23
	42	021209242	27,27
	54	021209254	52,09



PUENTE  
H-H 85 CU

	12	021208512	3,96
	15	021208515	4,88
	18	021208518	13,16
	22	021208522	17,63



CURVA 45°  
M-H 40 CU

10	12	021204012	1,89
25	15	021204015	0,85
10	18	021204018	2,02
10	22	021204022	1,96
10	28	021204028	4,16
10	35	021204035	15,69
	42	021204042	27,40
	54	021204054	45,07

10	12 x 10	021204031	2,55
10	15 x 12	021204063	1,40
25	18 x 12	021204093	3,34
10	18 x 15	021204096	1,17
10	22 x 12	021204043	6,40
10	22 x 15	021204046	3,18
10	22 x 18	021204049	2,18
	28 x 15	021204006	7,04
	28 x 18	021204009	6,86
	28 x 22	021204004	3,40
	35 x 18	021204089	17,41
	35 x 22	021204084	13,62
	35 x 28	021204080	16,73
	42 x 28	021204060	23,98
	42 x 35	021204068	18,77
	54 x 35	021204098	28,90
	54 x 42	021204097	24,87



REDUCCIÓN  
H-H 240 CU

10	12	021204112	2,76
25	15	021204115	0,92
10	18	021204118	1,96
10	22	021204122	2,26
10	28	021204128	4,07
10	35	021204135	14,24
	42	021204142	25,06
	54	021204154	45,07



CURVA 45°  
H-H 41 CU

## COBRE

□ MEDIDA REF. €/mtr.

□ MEDIDA REF. €



TE REDUCIDA  
130 CUR

15x12x12	021206633	5,32
15x12x15	021206636	2,62
15x15x12	021206637	4,19
15x18x15	021206696	6,56
15x22x15	021206646	8,41
18x12x12	021206933	9,06
18x12x15	021206936	7,37
18x15x15	021206966	3,18
18x15x18	021206969	1,93
18x18x15	021206996	3,89
18x22x18	021206949	8,99
22x15x15	021206466	5,76
22x15x18	021206469	6,38
22x15x22	021206464	2,74
22x18x15	021206496	7,86
22x18x18	021206499	6,83
22x18x22	021206494	4,19
22x22x15	021206446	8,73
22x22x18	021206449	10,35
28x15x15	021206043	15,05
28x15x28	021206060	6,39
28x18x28	021206090	11,25
28x22x22	021206044	13,21
28x22x28	021206045	7,13
28x28x15	021206006	25,63
28x28x18	021206009	22,14
28x28x22	021206004	17,46
35x22x35	021206848	20,50
42x22x42	021206501	31,78



MANGUITO UNIÓN  
H-H 270 CU

10	10	021202710	0,60
10	12	021202712	0,51
25	15	021202715	0,46
10	18	021202718	0,71
10	22	021202722	1,16
10	28	021202728	2,11
10	35	021202735	5,22
	42	021202742	9,98
	54	021202754	16,62



TAPÓN HEMBRA  
301 CU

10	12	021203012	2,35
25	15	021203015	1,22
10	18	021203018	1,50
10	22	021203022	2,56
	28	021203028	4,88



RACOR CON  
REBORDE  
359 GLCU

25	1/2"x12	021606032	1,73
25	1/2"x15	021606062	1,70
25	1/2"x18	021606092	2,45
25	1/2"x22	021606041	2,36
25	3/4"x15	021606063	2,94
25	3/4"x18	021606093	2,80
25	3/4"x22	021606043	3,12
25	3/4"x28	021606039	2,48
25	1"x22	021606044	4,51
25	1"x28	021606042	6,04
10	1 1/4"x28	021606045	8,67
10	1 1/4"x35	021606085	9,81
5	1 1/2"x42	021606104	6,64
4	2"x54	021606105	9,50

10	12 x 10	021204360	2,14
10	15 x 12	021204363	0,99
25	18 x 12	021204393	2,48
10	18 x 15	021204396	0,85
10	22 x 12	021204343	5,70
10	22 x 15	021204346	1,57
10	22 x 18	021204349	1,59
	28 x 12	021204303	9,99
	28 x 15	021204306	5,91
	28 x 18	021204309	6,51
	28 x 22	021204304	2,69
	35 x 18	021204364	10,38
	35 x 22	021204380	13,41
	35 x 28	021204383	8,88
	42 x 22	021204384	24,02
	42 x 28	021204389	26,07
	42 x 35	021204390	16,02
	54 x 35	021204397	36,86
	54 x 42	021204398	29,94



CURVO CON  
REBORDE  
2 AGLCU

25	1/2"x12	021200261	2,83
25	1/2"x15	021200262	2,73
25	1/2"x18	021200292	3,15
25	3/4"x18	021200293	4,48
25	3/4"x22	021200243	4,63
	1"x22	021200244	7,73



REDUCCION  
M-H 243 CU



RACOR PLANO  
359 P-GLCU



10	1/2"x12	100504529	1,84
10	1/2"x15	100504531	1,89
10	1/2"x18	100504533	2,69
10	1/2"x22	100504534	5,02
10	3/4"x15	100504536	3,18
10	3/4"x18	100504538	2,88
10	3/4"x22	100504539	3,40
10	1"x22	100504542	5,12

## TUBERÍA DE COBRE

Ø	ACABADO	LARGO	REF.	€/mtr.	Ø	ACABADO	LARGO	REF.	€/mtr.		
 TIRAS	10 x 12	Pulido	5 mts.	640011200	3,77	 ROLLO	8 x 10	<b>Cromo</b>	25 mts.	640000810	5,10
	13 x 15	Pulido	5 mts.	640011500	4,65		10 x 12	<b>Cromo</b>	25 mts.	640001012	5,76
	16 x 18	Pulido	5 mts.	640011800	5,70		8 x 10	Pulido	50 mts.	640000010	3,37
	20 x 22	Pulido	5 mts.	640012200	7,01		10 x 12	Pulido	50 mts.	640000012	4,68
	26 x 28	Pulido	5 mts.	640012800	8,97		13 x 15	Pulido	50 mts.	640000015	4,67
	33 x 35	Pulido	5 mts.	640013500	10,93		16 x 18	Pulido	50 mts.	640000018	3,77
	40 x 42	Pulido	5 mts.	640014200	13,50						
	52 x 54	Pulido	5 mts.	640015400	20,95						

\* Los precios son orientativos. Confirmar precios en el momento de la compra

## FONCAL









Ø	ACABADO	REF.	€/mtr.	Ø	ACABADO	REF.	€/mtr.		
 ROLLO 50 mts.	16	<b>AZUL</b>	081000016	0,46	 ROLLO 50 mts.	16	<b>ROJO</b>	081016000	0,46
	19	<b>AZUL</b>	081000019	0,58		19	<b>ROJO</b>	081019000	0,58
	23	<b>AZUL</b>	081000023	0,76		23	<b>ROJO</b>	081023000	0,76
	29	<b>AZUL</b>	081000029	1,27		29	<b>ROJO</b>	081029000	1,27

## SOLDADURA

ESTANO	U/E	REF.	NETO	ACABADO	REF.	€	
	Cobre 3,5%	991332836	6,92		POLVO PLATEX 125 grs.	991322722 11,06	
	Cobre 6%	991332837	6,92				
	CU 2 mm.	84	991332841	0,49		DECAPANTE 80 grs.	991322720 6,00
	Ag 5% 2 mm.	82	991332842	1,33			

\* Los precios son orientativos. Confirmar precios en el momento de la compra

## ACCESORIOS COMPRESIÓN COBRE E INOXIDABLE

MEDIDA	REF.	€/NETO	MEDIDA	REF.	€/NETO		
 CODO	15	027866415	2,52	 RACOR MACHO	15x1/2	027863152	1,94
	18	027866418	3,74		18x1/2	027863182	2,48
	22	027866422	4,95		22x3/4	027863223	3,61
 TE	15	027868015	4,03	 RACOR HEMBRA	15x1/2	027866152	2,08
	18	027868018	5,75		18x1/2	027866182	2,68
	22	027868022	7,17		22x3/1	027866223	3,61
 MANGUITO	15	027866015	2,52	 CODO HEMBRA	15x1/2	027865152	2,73
	18	027866018	3,44		18x1/2	027865182	3,83
	22	027866022	4,50		22x3/1	027865222	4,77
 REDUCCIÓN	18x15	027861815	3,65	 TE HEMBRA	15x1/2	027860152	4,11
	22x18	027862218	5,04		18x1/2	027860182	5,75
					22x3/1	027860222	7,00



Almacén de Fontanería

**Regístrate en nuestro ecommerce**

Descúbrelo en  
**tienda.suministroscoplasa.es**

Podrás consultar tus documentos  
**Ofertas - Pedidos - Albaranes - Facturas**



También pedir  
**materiales 24h**



*Fácil, rápido y GRATIS*

Captura con tu móvil este código QR  
para acceder a un vídeo explicativo.

**INOXIDABLE PRENSADO** (Mordaza Perfil M) Fuerza 32kn

AISI 304	AISI 304	€/mtr.
15x0,6	628701506	1,22
18x0,7	628701807	1,65
22x0,7	628702207	1,98
28x0,8	628702808	3,50
35x1	628703510	5,05
42x1,2	628704212	6,09
54x1,2	628705412	7,94

BARRA 5 mts.



RACOR MACHO

MEDIDA	REF.	€
15x1/2	028724152	7,59
15x3/4	028724153	9,10
18x1/2	028724182	7,99
18x3/4	028724183	8,97
22x1/2	028724222	9,73
22x3/4	028724223	10,15
22x1/2	028724224	10,68
28x1	028724284	13,51
35x1"1/4	028724355	17,48
42x1"1/2	028724426	24,67
54x2	028724542	28,53

CURVA HH



15	028709015	5,34
18	028709018	5,99
22	028709022	7,25
28	028709028	9,03
35	028709035	13,92
42	028709042	21,98
54	028709054	29,80



RACOR HEMBRA

15x1/2	028727152	7,99
15x3/4	028727153	10,42
18x1/2	028727182	8,49
18x3/4	028727183	9,17
22x1/2	028727222	10,62
22x3/4	028727223	10,84
22x1	028727224	12,75
28x3/4	028727283	14,82
28x1	028727284	15,10
35x1"1/4	028727355	17,45
42x1"1/2	028727426	24,96
54x2	028727547	32,30



CURVA MH

15	028709215	5,02
18	028709218	5,70
22	028709222	7,21
28	028709228	8,88
35	028709235	13,92
42	028709242	21,67
54	028709254	28,82



REDUCCIÓN

18.15	028781815	3,99
22.15	028782215	4,42
22.18	028782218	4,47
28.15	028782815	7,19
28.18	028782818	5,96
28.22	028782822	7,19
35.15	028783515	15,67
35.18	028783518	12,00
35.22	028783522	7,95
35.28	028783528	8,15
42.15	028784215	15,56
42.18	028784218	15,49
42.22	028784222	12,74
42.28	028784228	13,32
42.35	028784235	9,78
54.42	028785442	12,24



MANGUITO HH

15	028727015	2,92
18	028727018	3,30
22	028727022	3,89
28	028727028	4,85
35	028727035	6,43
42	028727042	8,30
54	028727054	9,95



CODO 45° H-H

15	028704115	5,39
18	028704118	5,80
22	028704122	6,92
28	028704128	8,80
35	028704135	13,25
42	028704142	20,22
54	028704154	26,86



CODO PLACA

15.1/2	028747152	10,97
18.1/2	028747182	11,37
22.3/4	028747223	14,15



CODO 45° M-H









15	028704015	5,55
18	028704018	6,11
22	028704022	7,27
28	028704028	8,87
35	028704035	12,32
42	028704042	19,45
54	028704054	24,77



TE 90°

15	028713015	8,72
18	028713018	9,73
22	028713022	10,73
28	028713028	12,91
35	028713035	16,57
42	028713042	22,47
54	028713054	27,48

INOXIDABLE

MEDIDA			REF.	€	MEDIDA			REF.	€
 <p>RACOR MÓVIL</p>	15x1/2	028735152	10,94		3/4x1/2	026090011	2,65		
	15x3/4	028735153	11,17		1"x3/4	026090012	3,70		
	18x1/2	028735182	12,09		1"1/4x1"	026090013	5,00		
	18x3/4	028735183	12,35		1"1/2x1"1/4	026090014	6,10		
	22x3/4	028735223	14,48		2"x1"1/2	026090015	12,15		
	22x1	028735224	16,33						
	28x1	028735284	17,98						
	28x1"1/4	028735285	20,02						
	35x1"1/4	028735355	20,41						
	42x1"1/2	028735426	27,55						
54x2	028735542	33,18							
 <p>TE R/H</p>	15x1/2	028713152	9,46		1/2"	026090021	2,00		
	18x1/2	028713182	9,58		3/4"	026090022	3,15		
	18x3/4	028713183	10,44		1"	026090023	5,15		
	22x1/2	028713222	11,66		1"1/4	026090024	7,95		
	22x3/4	028713223	12,63		1"1/2	026090025	9,40		
	28x1/2	028713282	13,50	2"	026090026	14,75			
	28x3/4	028713283	14,49						
	28x1	028713284	15,98		1/2"	026090051	3,90		
	35x1/2	028713352	14,97		3/4"	026090052	5,65		
	35x3/4	028713353	17,71		1"	026090053	9,10		
35x1	028713354	18,71	1"1/4		026090054	14,40			
35x1"1/4	028713355	18,69	1"1/2		026090055	18,30			
42x1"1/2	028713426	27,85	2"	026090056	29,20				
54x2	028713547	47,27							
 <p>TE REDUCIDA</p>	18x15x18	028706969	8,77		1/2"	026090001	2,70		
	22x15x22	028706464	9,42		3/4"	026090002	4,15		
	22x18x22	028706494	9,71		1"	026090003	7,20		
	28x15x28	028706060	11,35		1"1/4	026090004	11,25		
	28x18x28	028706090	11,71		1"1/2	026090005	14,70		
	28x22x28	028706040	12,22		2"	026090006	22,60		
	35x28x35	028706808	15,06						
	42x35x42	028706686	21,90						
	54x42x54	028706979	27,39						
	42x15x42	028706666	18,82						
35x15x35	028706868	13,85							
42x18x42	028706668	18,82							
42x22x42	028706678	20,34							
42x28x42	028706688	21,13							
 <p>CODO R/H</p>	15x1/2	028790152	10,20	 <p>VALV. BOLA</p>	1/2"	026090031	14,76		
	18x1/2	028790182	10,90		3/4"	026090032	18,82		
	18x3/4	028790183	12,90		1"	026090033	23,17		
	22x3/4	028790223	13,44		1"1/4	026090034	35,73		
	28x1"	028790284	18,42		1"1/2	026090035	64,78		
					2"	026090036	94,27		

LATÓN

□	MEDIDA	REF.	€/mtr.	□	MEDIDA	REF.	€
---	--------	------	--------	---	--------	------	---



MACHÓN DOBLE

25	1/4	500656000	1,06
25	3/8	500656001	1,28
25	1/2	500656002	1,39
25	3/4	500656003	2,36
10	1"	500656004	4,12
10	1 1/4	500656005	7,08
10	1 1/2	500656006	9,26
	2"	500656007	14,86
	2 1/2	500656008	23,62
	3"	500656009	34,78



ALARGADERA REDUCIDA

25	M1/8xH1/4	500605022	1,29
25	M3/8xH1/2	500605026	1,39
25	M1/2xH3/4	500605028	2,00
10	M3/4xH1"	500605031	3,50
10	M1"xH1 1/4"	500605036	5,51
10	M1"xH1 1/2"	500605037	7,76
5	M1 1/4xH1 1/2"	500605039	8,39
5	M1 1/2xH2"	500605041	11,68
10	H1xM1/2	500605029	3,15
	H2xM3/4	500605033	11,02
	H2xM1	500605038	11,92
	H2xM1 1/4	500605040	12,03



		NETO	
40	MACHÓN 1/2	500600001	30,00
40	ALARG. 1/2x1cm	500600002	33,00
25	ALARG. 1/2x2cm	500600003	27,00
20	MACHÓN 3/4	500600004	25,00
50	TAPÓN 1/2	500600005	30,00



MACHÓN RED

25	1/4 x 3/8	500657001	1,27
25	3/8 x 1/2	500657021	1,40
25	1/2 x 3/4	500657032	1,92
10	1/2 x 1"	500657042	3,38
10	3/4 x 1"	500657043	3,51
10	3/4 x 1 1/4	500657053	5,26
10	1" x 1 1/4	500657045	5,63
	1" x 1 1/2	500657046	7,15
	1" x 2"	500657047	11,97
10	1 1/4 x 1 1/2	500657056	8,21
	1 1/4 x 2"	500657057	11,87
	1 1/2 x 2"	500657067	12,39
	2" x 2 1/2	500657078	23,95
	2" x 3"	500657079	37,03
	2 1/2 x 3"	500657089	36,23



REDUCCIÓN EXAGONAL M-H

25	1/2x1/4	500680024	1,37
25	3/8x1/4	500680010	1,00
25	1/2x3/8	500680021	1,24
25	3/4x1/2	500680032	1,53
25	1"x1/2	500680042	3,04
25	1"x3/4	500680043	2,54
10	1 1/4x1/2	500680052	5,66
10	1 1/4x3/4	500680053	5,53
10	1 1/4x1"	500680054	4,61
10	1 1/2x1/2	500680062	6,84
10	1 1/2x3/4	500680063	6,57
10	1 1/2x1"	500680064	6,75
10	1 1/2x1 1/4	500680065	5,15
5	2"x1/2	500680072	12,05
5	2"x3/4	500680073	12,83
5	2"x1"	500680074	12,32
5	2"x1 1/4	500680075	12,71
5	2"x1 1/2	500680076	10,00
	2 1/2x2"	500680085	21,43
	3"x2"	500680095	40,98
	3x2 1/2	500680096	33,13



ALARGADERA M-H













25	3/8	500605015	1,16
25	1/2	500605016	1,52
25	1/2 x 2cm.	500605020	1,96
25	3/4	500605017	2,41
10	1"	500605018	3,74
10	1 1/4	500605019	6,04
Cromo			
	1/2 x 5 cm.	500605052	9,29
	1/2 x 10 cm.	500605053	13,36



RACOR DEPÓSITO







3/8	991368001	2,93
1/2	991368002	3,71
3/4	991368003	5,59
1"	991368004	7,26
1 1/4	991368005	11,89
1 1/2	991368006	17,59
2"	991368007	32,16
2 1/2	991368008	57,35
3"	991368009	86,92

LATÓN

□ MEDIDA REF. €/mtr.				□ MEDIDA REF. €					
 <p>CODO H-H</p>	25	3/8	500300901	2,20	 <p>TAPÓN MACHO</p>	25	3/8	500329001	0,97
	25	1/2	500300902	3,34		25	1/2	500329002	1,15
	10	3/4	500300903	5,02		25	3/4	500329003	1,80
	10	1"	500300904	9,16		25	1"	500329004	2,83
		1 1/4	500300905	15,01		10	1 1/4	500329005	4,09
		1 1/2	500300906	21,27		10	1 1/2	500329006	5,97
		2"	500300907	31,49		10	2"	500329007	8,57
		2 1/2	500300908	65,16					
 <p>CODO M-H</p>  <p>TUERCA MÓVIL</p>	25	3/8	500300921	2,13	 <p>TAPÓN HEMBRA</p>	25	3/8	500303001	0,83
	25	1/2	500300922	3,41		25	1/2	500303002	1,12
	10	3/4	500300923	5,44		25	3/4	500303003	1,52
	10	1"	500300924	8,97		10	1"	500303004	2,50
		1 1/4	500300925	14,63		10	1 1/4	500303005	4,11
		1 1/2	500300926	22,23		10	1 1/2	500303006	5,09
		2"	500300927	30,18		10	2"	500303007	8,99
		2 1/2	500300928	72,29					
		1/2	500300932	3,69					
		3/4	500300933	5,57					
 <p>TE H-H-H</p>	25	3/8	500301301	2,76	 <p>RÁCOR CONTADOR</p>	3/4 x 1/2	991360102	4,31	
	10	1/2	500301302	4,05		1" x 3/4	991360103	6,71	
	10	3/4	500301303	5,72		7/8 x 1/2	991360178	4,98	
	5	1"	500301304	10,18					
		1 1/4	500301305	17,31					
		1 1/2	500301306	28,69					
		2"	500301307	43,21					
	2 1/2	500301308	91,46						
 <p>MANGUITO H-H</p> 	25	3/8	500302701	1,91	 <p>EMPLAZAMIENTO CONTADOR</p>	3/4 - 3/4	991360379	19,00	
	25	1/2	500302702	2,21		3/4 - 7/8	991360378	21,04	
	10	3/4	500302703	3,18					
	10	1"	500302704	4,70					
	5	1 1/4	500302705	8,31					
	5	1 1/2	500302706	11,56					
		2"	500302707	20,76					
		2" 1/2	500302708	41,87					
		1/2 x 3/4	500665203	2,67					
		1/2 x 1"	500665204	3,40					
 <p>UNIÓN 3 PIEZAS H-H</p>	1/2	500303402	7,75	 <p>COLLARÍN CON TOMA</p>	20 x 1/2	991314600	7,65		
	3/4	500303403	12,74		25 x 1/2	991314601	8,06		
	1"	500303404	16,09		32 x 1/2	991314602	10,32		
	1 1/4	500303405	25,89		40 x 1/2	991314603	16,25		
	1 1/2	500303406	32,78		40 x 3/4	991314607	15,45		
	2"	500334007	34,73		50 x 1/2	991314604	15,73		
	2 1/2	500334008	116,42		50 x 3/4	991314608	15,59		
						63 x 1/2	991314605	26,29	
				63 x 3/4	991314609	25,74			



LATÓN

□ MEDIDA REF. €/mtr.				□ MEDIDA REF. €					
 <p>90 G Cu CODO HEMBRA</p>	10	3/8 x 12	021609031	3,56	 <p>243 G Cu ENTROQUE MACHO</p>	25	3/8 x 12	021604331	1,84
	25	3/8 x 15	021609061	2,79		25	3/8 x 15	021604361	1,76
	25	1/2 x 12	021609032	2,93		25	1/2 x 12	021604332	2,30
	25	1/2 x 15	021609062	3,34		25	1/2 x 15	021604362	2,23
	25	1/2 x 18	021609092	3,86		25	1/2 x 18	021604392	2,60
	10	1/2 x 22	021609042	5,70		25	1/2 x 22	021604342	3,21
	10	3/4 x 15	021609063	6,25		25	3/4 x 15	021604363	3,48
	10	3/4 x 18	021609093	5,73		25	3/4 x 18	021604393	3,32
	10	3/4 x 22	021609043	6,20		25	3/4 x 22	021604343	3,59
	10	3/4 x 28	021609045	10,46		10	3/4 x 28	021604303	6,15
	10	1" x 22	021609044	10,25		10	1" x 22	021604344	5,90
	10	1" x 28	021609004	12,15		10	1" x 28	021604304	5,22
		1 1/4 x 35	021609048	20,49		10	1 1/4 x 28	021604305	10,18
		1 1/2 x 42	021609049	38,75			1 1/4 x 35	021604306	10,73
		2" x 54	021609050	66,41			1 1/2 x 42	021604307	13,24
					2" x 54	021604308	24,77		
 <p>92 G Cu CODO MACHO</p>	10	1/2 x 12	021609232	3,11	 <p>270 G Cu ENLACE HEMBRA</p>	25	3/8 x 12	021607031	1,63
	25	1/2 x 15	021609243	4,08		25	3/8 x 15	021607061	1,76
	25	1/2 x 18	021609262	3,95		25	1/2 x 12	021607032	2,21
	10	3/4 x 18	021609263	4,80		25	1/2 x 15	021607062	2,43
	10	3/4 x 22	021609292	5,32		25	1/2 x 18	021607092	2,63
						25	1/2 x 22	021607042	3,12
						25	3/4 x 15	021607063	3,08
						25	3/4 x 18	021607093	2,97
						25	3/4 x 22	021607043	3,20
						10	3/4 x 28	021607003	5,70
				10	1" x 22	021607044	5,35		
				10	1" x 28	021607004	5,93		
					1 1/4 x 35	021607006	12,15		
				5	1 1/2 x 42	021607046	14,92		
					2" x 54	021607097	26,89		
 <p>130 G Cu TE HEMBRA SOLDAR</p>	25	1/2 x 12	021603032	4,28	 <p>472 G Cu CODO MURAL</p>	1/2 x 12	021607263	4,80	
	25	1/2 x 15	021603062	4,18		1/2 x 15	021607264	4,61	
	25	1/2 x 18	021603092	4,48		1/2 x 18	021607265	7,05	
	10	1/2 x 22	021603042	8,74					
	10	3/4 x 18	021603093	9,00					
	10	3/4 x 22	021603043	9,05					
	10	1" x 22	021603045	11,17					
		1" x 28	021603046	15,85					
		1 1/4 x 35	021603075	34,62					
		1 1/2 x 42	021603066	53,74					
	2" x 54	021603097	84,98						



# ISOLTUBEX®



Sistema MULTICAPA  
Sistema I-PERT  
Sistema SUELO RADIANTE



Accesorios de Compresión  
Accesorios de Compresión  
para tubería de Cobre/Inox  
Accesorios de Casquillo Corredizo  
Accesorios de Latón para Roscar











Tuberías y Accesorios de Polipropileno

Suelo radiante  
Regulación y control











[www.isoltubex.net](http://www.isoltubex.net)

















## MULTICAPA ISOLTUBEX (Mordaza Perfil RF - Fuerza 32 kN)

□ MEDIDA				REF.	€/mtr.	□ MEDIDA				REF.	€												
				16x2 100MTS.	627011620	2,52					16 x 2 AZUL	50mts	627051621	4,02									
				20x2 100MTS	627012020	3,42					20 x 2 AZUL	50mts	627052021	4,79									
				25x2,5 50MTS	627012525	4,87					25 x 2,5 AZUL	25mts	627052521	10,93									
				32x3 50 MTS.	627013230	7,50									16 x 2 ROJO	50mts	627051620	4,02					
				16x2 25MTS.	627031620	2,86									20 x 2 ROJO	50mts	627052020	4,79					
				20x2 25MTS.	627032020	3,60					25 x 2,5 ROJO	25mts	627052520	10,93									
<b>ROLLO</b>						<b>ROLLO AISLADO (50mts)</b>																	
				200	16 x 2	627021620	3,04																
				140	20 x 2	627022020	3,79																
				80	25 x 2,5	627022525	6,59																
				56	32 x 3	627023230	12,13																
				64	40 x 4	627024040	18,70																
				16	50 x 4,5	627025045	23,98																
				12	63 x 6	627026360	42,48																
<b>BARRA (4 mts.)</b>						<b>BARRA (4 mts.)</b>																	
				30	16 - 1/2	027090162	4,11					20	16-16-16	027013016	4,41								
				22	20 - 1/2	027090202	4,70					14	20-20-20	027013020	6,32								
				15	20 - 3/4	027090203	5,16					6	25-25-25	027013025	11,36								
				12	25 - 1/2	027090252	6,04					4	32-32-32	027013032	15,81								
				10	25 - 3/4	027090253	7,03									40-40-40	027013040	44,93					
				8	25 - 1	027090254	8,82																
				8	32 - 3/4	027090323	8,14																
				8	32 - 1	027090324	10,31																
												8	40 - 1 1/4	027090401	21,91								
				<b>CODO HEMBRA</b>								<b>TE</b>											
				40	16 - 1/2	027027072	3,30					16	16 - 1/2	027013072	5,91								
				35	20 - 1/2	027027022	3,53					12	20 - 1/2	027013022	6,64								
				30	20 - 3/4	027027023	4,31					10	20 - 3/4	027013023	7,62								
				20	25 - 1/2	027027082	4,76					8	25 - 1/2	027013082	9,44								
				20	25 - 3/4	027027073	5,30					7	25 - 3/4	027013073	11,20								
				12	25 - 1	027027074	7,23					5	25 - 1	027013074	12,82								
				12	32 - 1	027027054	7,47					4	32 - 3/4	027013053	12,88								
												12	40 - 1 1/4	027027075	15,60	3	32 - 1	027013054	15,12				
																40 - 1 1/4	027013055	40,00					
<b>RACOR FIJO HEMBRA</b>						<b>TE HEMBRA</b>																	
				14	16 - 1/2	027094162	6,09					32	16 - 16	027009016	3,19								
				12	20 - 1/2	027094202	6,71					22	20 - 20	027009020	4,46								
				10	20 - 3/4	027094203	8,51					11	25 - 25	027009025	7,79								
												10	25 - 3/4	027094253	8,60	6	32 - 32	027009032	11,38				
								40 - 40	027009040	29,96													
<b>CODO PLACA</b>						<b>CODO</b>																	























## MULTICAPA ISOLTUBEX (Mordaza Perfil RF)

	□	MEDIDA	REF.	€		□	MEDIDA	REF.	€
	48	16 - 1/2	027035972	3,22		50	16 - 1/2	027024372	2,86
	30	20 - 1/2	027035922	3,63			16 - 3/4	027024383	4,00
	24	20 - 3/4	027035923	5,19		40	20 - 1/2	027024322	3,27
	20	25 - 1/2	027035982	7,32		35	20 - 3/4	027024323	4,34
	18	25 - 3/4	027035973	8,00		20	25 - 1/2	027024382	4,56
	14	25 - 1	027035974	11,00		18	25 - 3/4	027024373	5,03
	14	32 - 1	027035954	12,52		16	25 - 1	027024374	6,61
					12	32 - 3/4	027024353	6,50	
					14	32 - 1	027024354	7,21	
						40 - 1 1/4	027024345	15,07	
	45	16 - 16	027027016	2,47		50	15-16	027028098	2,30
	30	20 - 20	027027020	3,48		30	18-20	027028099	3,40
	15	25 - 25	027027025	6,30		20	22-25	027028100	4,31
	10	32 - 32	027027032	8,31					
		40 - 40	027027040	20,41					
	37	20 - 16	027024047	3,54		20	16-20-16	027006729	5,50
	20	25 - 16	027024077	5,12		14	20-16-16	027006277	5,26
	20	25 - 20	027024072	5,23		18	20-16-20	027006272	5,55
		32 - 20	027024052	6,95			20-20-16	027006227	6,28
	12	32 - 25	027024057	7,56			20-25-20	027006282	9,71
		40 - 32	027024045	18,40			25-16-16	027006777	6,94
							25-16-20	027006782	7,94
						9	25-16-25	027006767	9,34
						9	25-20-16	027006727	7,48
						10	25-20-20	027006722	8,66
						8	25-20-25	027006728	10,80
						7	25-25-20	027006772	10,23
					5	25-32-25	027006757	14,49	
					5	32-25-25	027006577	13,38	
					5	32-20-32	027006525	13,44	
					5	32-25-32	027006575	13,74	
					5	32-32-25	027006557	14,67	
	25	16 x 1/2	027092162	4,56		027019003		3,49	
		20 x 1/2	027092202	5,19					
		20 x 3/4	027092034	6,20					
	12	25 x 3/4	027092253	8,09					
	8	16 x 1/2	027019001	7,87					
	8	20 x 1/2	027019002	8,05					

## MULTICAPA ISOLTUBEX

	□	MEDIDA	REF.	€		□	MEDIDA	REF.	€
 <b>CALIBRADOR</b>		16 x 18 x 20	027028030	18,00					
		20 x 25 x 32	027028035	20,00					
 <b>MUELLE</b>	Exterior	16	027028016	11,41					
		20	027028020	13,65					
		25	027028025	15,28					
	Interior	16	027050016	8,15					
		20	027050020	8,81					
		25	057050025	9,73					
		32	027050032	14,86					
 <b>COLECTOR CON EUROCONOS 16</b>		1"-2 SALIDAS	027201212	18,00					
		1"-3 SALIDAS	027201312	21,00					
 <b>TAPÓN RECUPERABLE</b>	48	16	027029016	3,76					
 <b>LUBRICANTE</b>			027028040	23,00					
 <b>EMPOTRAR PLADUR</b>	5	16	027039916	14,21					
	5	20	027039920	14,70					
	5	25	027039925	20,60					
		32	027039932	23,29					
 <b>EMPOTRAR</b>	5	16	027040016	12,18					
	5	20	027040020	13,40					
	5	25	027040025	18,83					
		32	027040032	20,61					
 <b>U PLADUR</b>	4	16U	027039816	20,83					
	4	20U	027039820	21,00					
	4	25U	027039825	22,90					
 <b>U</b>	4	20U	027040120	19,17					
	4	25U	027040125	20,70					
 <b>VISTA</b>	5	16	027045016	10,11					
	5	20	027045020	10,86					
	5	25	027045025	17,49					
	4	32	027045032	20,46					
 <b>KIT ALARGADERA MONTURA</b>									
				027028096					
 <b>PROLONGADOR VÁLVULA</b>									
				027019000					
 <b>PALANCA</b>	5	PALANCA	027050001	7,48					
 <b>OCULTO</b>	5	OCULTO	027050002	6,41					
 <b>PALANCA NEGROS</b>	5	PALANCA	027050000	7,90					
 <b>OCULTO NEGROS</b>	5	OCULTO	027050003	6,90					

## POLIETILENO RETICULADO

MEDIDA				REF.	€	MEDIDA				REF.	€											
 <p><b>ROLLO</b></p>					16x2 100MTS.	627050016	1,37	 <p><b>TE</b></p>														
					20x2 100MTS	627050020	1,88															
					25x2,5 50MTS	627050025	2,55															
					32x3 50 MTS.	627050032	4,61															
 <p><b>BARRA (4 mts.)</b></p>					200 16 x 2	627050216	1,44	 <p><b>TE HEMBRA</b></p>														
					140 20 x 2	627050220	2,03															
					80 25 x 2,5	627050225	2,67															
					56 32 x 3	627050232	4,68															
					30 16 - 1/2	027509001	3,60															
 <p><b>CODO HEMBRA</b></p>					22 20 - 1/2	027509003	4,50	 <p><b>CODO</b></p>														
					15 20 - 3/4	027509004	4,87															
					12 25 - 1/2	027509005	5,96															
					10 25 - 3/4	027509006	6,35															
					8 25 - 1	027509007	7,95															
 <p><b>RACOR FIJO HEMBRA</b></p>					8 32 - 1	027509008	9,47	 <p><b>RACOR FIJO MACHO</b></p>														
					40 16 - 1/2	027527001	2,68															
					35 20 - 1/2	027527002	3,34															
					30 20 - 3/4	027527003	4,03															
					20 25 - 1/2	027527004	4,37															
 <p><b>CODO PLACA</b></p>					20 25 - 3/4	027527005	4,80	 <p><b>RACOR MOVIL HEMBRA</b></p>														
					12 25 - 1	027527006	6,46															
					12 32 - 1	027527008	6,79															
					14 16 - 1/2	027509009	5,46															
					12 20 - 1/2	027509010	6,22															
 <p><b>MANGUITO</b></p>					45 16 - 16	027527016	2,49	 <p><b>EMPOTRAR</b></p>														
					30 20 - 20	027527020	3,56															
					15 25 - 25	027527025	5,56															
					10 32 - 32	027527032	7,62															
 <p><b>REDUCCIÓN</b></p>					37 20 - 16	027524001	2,66	 <p><b>PALANCA</b></p>														
					20 25 - 16	027524002	4,01															
					20 25 - 20	027524003	4,89															
					12 32 - 20	027524005	6,31															
 <p><b>TAPÓN RECUPERABLE</b></p>					16	027029016	3,76	 <p><b>OCULTO</b></p>														
 <p><b>TE REDUCIDA</b></p>					18 20-16-16	027513002	4,43	 <p><b>PALANCA OCULTO</b></p>														
					14 20-16-20	027513003	5,05															
					18 20-20-16	027513004	5,26															
					9 25-20-16	027513006	6,55															
					10 25-20-20	027513007	7,34															
					8 25-20-25	027513008	8,69															
					7 25-25-20	027513009	8,69															
					5 32-25-25	027513010	11,71															
					5 32-25-32	027513011	12,68															
					5 32-32-25	027513012	13,68															
					 <p><b>PALANCA OCULTO</b></p>								5	027050001	7,48	 <p><b>OCULTO</b></p>						
					 <p><b>PALANCA OCULTO</b></p>								5	027050002	6,41	 <p><b>OCULTO</b></p>						

## MULTICAPA MULTISTANDARD (Mordaza Perfil U)

MEDIDA			REF.	€	MEDIDA			REF.	€
	16x2 100MTS.	627540016	244,64		16 - 1/2	027565040	4,84		
	20x2 100MTS	627540020	349,30		20 - 1/2	027565045	5,79		
	25x2,5 50MTS	627540025	281,89		20 - 3/4	027565046	6,34		
	32x3 50 MTS.	627540032	455,61		25 - 3/4	027565049	9,97		
<b>ROLLO</b>							25 - 1	027565050	10,91
							32 - 1	027565052	16,71
	16 x 2	627541016	12,34		16 - 1/2	027565020	3,83		
	20 x 2	627541020	16,51		20 - 1/2	027565024	5,68		
	25 x 2,5	627541025	28,50		20 - 3/4	027565025	6,04		
	32 x 3	627541032	46,06		25 - 3/4	027565027	11,44		
<b>BARRA (4mts.)</b>							25 - 1	027565028	12,09
							32 - 1	027565031	15,22
	16 - 1/2	027565090	5,23		16 - 16	027565000	4,22		
	20 - 1/2	027565094	6,64		20 - 20	027565002	5,51		
	20 - 3/4	027565095	7,60		25 - 25	027565003	9,52		
	25 - 3/4	027565098	11,19		32 - 32	027565004	15,18		
	32 - 1	027565102	19,78						
	16 - 1/2	027565110	8,64		20 - 16	027565011	5,37		
	20 - 1/2	027565113	10,17		25 - 16	027565013	8,17		
			25 - 20		027565015	9,16			
			32 - 20		027565016	11,83			
			32 - 25		027565017	14,46			
	16-16-16	027565120	6,66		16 - 16	027565060	5,20		
	20-20-20	027565122	9,02		20 - 20	027565062	6,94		
	25-25-25	027565123	16,86		25 - 25	027565063	11,07		
	32-32 -32	027565124	30,52		32 - 32	027565064	18,63		
	16 - 1/2	027565280	5,56		16-20-16	027565131	8,15		
	20 - 1/2	027565282	6,67		20-16-16	027565136	8,15		
	20 - 3/4	027565283	7,30		20-16-20	027565137	8,40		
	25 - 3/4	027565284	11,47		20-20-16	027565142	8,40		
			25-16-20		027565151	12,81			
			25-16-25		027565140	12,69			
			25-20-20		027565153	12,81			
			25-20-25		027565143	13,36			
			25-25-20		027565144	13,36			
			32-25-25		027565149	24,74			
			32-20-32		027565148	24,32			
			32-25-32		027565150	24,74			
	16 - 1/2	027565170	7,44						
	20 - 1/2	027565175	9,63						
	20 - 3/4	027565176	8,27						
	25 - 3/4	027565179	18,80						
	32 - 3/4	027565182	25,98						

## MULTICAPA MULTISTANDARD (Mordaza Perfil U)

MEDIDA			REF.	€	MEDIDA			REF.	€	
			<b>KIT ALARGADERA MONTURA</b>	<b>027535184</b>	<b>7,20</b>				<b>028035190</b>	<b>6,24</b>
			16 - 16	027635850	17,47					
			20 - 20	027635852	18,56					
			25 - 25	027635854	22,43					
			32 - 32	027635942	28,60					
<b>LLAVE EMPOTRAR KANSAS</b>						<b>MANDO OCULTO</b>				
			16 - 16	027635753	17,76				<b>028035191</b>	<b>7,24</b>
			20 - 20	027635754	22,24					
			25 - 25	027635755	27,98					
			<b>LLAVE EMPOTRAR EN "U"</b>							
			16 - 16	027635650	13,32					
			20 - 20	027635652	14,89					
			25 - 25	027635654	17,02					

## MULTICAPA COMPRESIÓN (SIN HERRAMIENTAS)

MEDIDA			REF.	€	MEDIDA			REF.	€		
			16	025964010	4,28				16 x 1/2	025965510	3,98
			20	025964015	6,76				20 x 1/2	025965520	5,76
			25	027227025	13,30				20 X 3/4	025965525	5,98
<b>UNIÓN REDUCIDA</b>									25 x 3/4	027292253	9,81
			20 - 16	025964510	6,20				16	025965010	4,59
			25 - 20	027242520	10,21				20	025965015	6,59
<b>RACOR MACHO</b>									25	027209025	11,95
			16 x 1/2	025963010	2,70				16	025960510	6,69
			20 x 1/2	025963020	3,36				20	025960515	10,18
			25 X 3/4	027235253	9,01				25	027213025	21,10
			<b>TE R/H</b>								
			16 x 1/2	025967010	9,72				16 x 1/2	025960010	4,96
			20 x 1/2	027213202	9,49				20 x 1/2	025960020	6,62
			20 X 3/4	025967020	13,87						



## POLIETILENO RET. -PEX-

MEDIDA ROLLO REF. €



PEX-A  
PARA FONTANERÍA  
<<ROLLO>>

100 mts	16 x 1,8	627049116	1,75
100 mts	20 x 1,9	627049120	2,11
50 mts	25 x 2,3	627049125	3,50
50 mts	32 x 2,9	627049132	5,93

PEX-A  
PARA FONTANERÍA  
<<BARRA>>

4 mts	16 x 1,8	627049416	1,78
4 mts	20 x 1,9	627049420	2,27
4 mts	25 x 2,3	627049425	3,58
4 mts	32 x 2,9	627049432	6,05

□ MEDIDA REF. €



CODO  
MASTER  
(PPSU)

32	16 x 16	026909216	1,97
22	20 x 20	026909220	2,27
11	25 x 25	026909225	3,80
6	32 x 32	026909232	7,33



REDUCCION

37	20 x 16	026902016	1,85
20	25 x 20	026902520	2,74
12	32 x 25	026903225	3,95

□ MEDIDA REF. €



TE MASTER  
(PPSU)

20	16x16x16	026909116	2,59
14	20x20x20	026909120	3,09
6	25x25x25	026909125	5,88
4	32x32x32	026909132	10,73



LLAVE DE CORTE  
DE EMPOTRAR

5	16 x 16	026881600	11,15
5	20 x 20	026882000	11,89
5	25 x 25	026882500	16,66
4	32 x 32	026883200	20,26



TE REDUCIDA  
MASTER  
(PPSU)

18	20x16x16	026920161	3,25
14	20x16x20	026920162	3,57
18	20x20x16	026920201	3,46
10	25x20x20	026925202	5,21
8	25x20x25	026925205	5,90
7	25x25x20	026925252	6,42
5	32x20x32	026932203	8,19
5	32x25x32	026932253	8,73
5	32x25x25	026932255	8,26



MANETA VISTA

5	027050001	7,48
---	-----------	------



MANGUITO  
UNIÓN MASTER  
(PPSU)











45	16 x 16	026909016	1,06
30	20 x 20	026909020	1,58
15	25 x 25	026909025	2,58
10	32 x 32	026909032	4,47



MANETA OCLTA

5	027050002	6,41
---	-----------	------

**POLIETILENO RET. -PEX-**

	□	MEDIDA	REF.	€		□	MEDIDA	REF.	€
 <p>TE R/H</p>	16	16 x 1/2"	026831612	4,11	 <p>RACOR FIJO HEMBRA</p>	40	16 x 1/2"	026851612	1,95
	12	20 x 1/2"	026832012	5,16		40	20 x 1/2"	026852012	2,34
	8	25 x 1/2"	026832512	7,10		35	20 x 3/4"	026852034	2,99
	7	25 x 3/4"	026832534	7,82		16	25 x 1"	026852510	5,23
	3	32 x 1"	026833210	12,65		18	25 x 3/4"	026852534	3,77
						14	32 x 1"	026853210	7,80
 <p>CODO BASE FIJACION CORTO</p>	14	16 x 1/2"	026811612	5,08	 <p>RACOR MOVIL</p>	48	16 x 1/2"	026861612	2,89
	12	20 x 1/2"	026812012	5,56		30	20 x 1/2"	026862012	3,32
						24	20 x 3/4"	026862034	3,71
						14	25 x 1"	026862510	8,27
						18	25 x 3/4"	026862534	4,65
 <p>LLAVE DE CORTE EN "U"</p>	4	16 x 16	026891600	17,08	 <p>UNION COBRE</p>	50	15 - 16	026871516	2,24
	4	20 x 20	026892000	18,35		45	18 - 20	026871820	2,53
	4	25 x 25	026892500	21,29		20	22 - 20	026872220	2,74
 <p>CODO TERMINAL</p>	ROSCA HEMBRA				 <p>ANILLO AZUL</p>	25	16 A	026907016	0,27
	30	16 x 1/2"	026801612	3,14		25	20 A	026907020	0,31
	22	20 x 1/2"	026802012	3,86		25	25 A	026907025	0,49
	15	20 x 3/4"	026802034	5,16		25	32 A	026907032	0,75
	10	25 x 3/4"	026802534	5,52					
	8	32 x 1"	026803210	8,96					
	ROSCA MACHO								
	25	16 x 1/2"	026821612	2,22					
	20	20 x 1/2"	026822012	3,48					
	 <p>RACOR FIJO MACHO</p>	50	16 x 1/2"	026841612	1,81	 <p>ANILLO ROJO</p>	25	16 R	026908016
40		16 x 3/4"	026841634	2,39	25		20 R	026908020	0,31
40		20 x 1/2"	026842012	2,22	25		25 R	026908025	0,49
35		20 x 3/4"	026842034	2,85	25		32 R	026908032	0,75
16		25 x 1"	026842510	5,20					
18		25 x 3/4"	026842534	3,63					
14		32 x 1"	026843210	6,58					

POLIPROPILENO (PP-R)

FASER  
(Barra 4 mts)



MEDIDA	SDR	REF.	€
20 x 2,8	7,4	192111100	1,54
25 x 3,5	7,4	192111200	2,25
32 x 4,4	7,4	192111300	3,65
40 x 5,5	7,4	192111400	5,23
50 x 6,9	7,4	192111500	8,26
63 x 8,6	7,4	192111600	13,03
75 x 10,3	7,4	192111700	19,65



MANGUITO

MEDIDA	REF.	€
16	192201116	0,24
20	192201100	0,18
25	192201200	0,29
32	192201300	0,45
40	192201400	0,69
50	192201500	1,23
63	192201600	2,49
75	192201700	4,42
90	192201900	6,71
110	192201101	9,41



CODO PALACA

25 x 1/2"	192268252	2,45
-----------	-----------	------



TE

20	192205100	0,33
25	192205200	0,56
32	192205300	0,86
40	192205400	1,39
50	192205500	2,74
63	192205600	5,19
75	192205700	7,30
90	192205800	13,49
110	192205900	23,31



CODO 90°

16	192203116	0,36
20	192203100	0,03
25	192203200	0,43
32	192203300	0,66
40	192203400	1,31
50	192203500	2,49
63	192203600	4,30
75	192203700	6,33
90	192203990	9,83
110	PPR.C90110	18,83



TE REDUCIDA

25x20x25	192206727	0,48
32x20x32	192206525	0,81
32x25x32	192206575	0,81
40x20x40	192206424	1,26
40x25x40	192206474	1,26
40x32x40	192206454	1,44
50x20x50	192206526	2,60
50x25x50	192206576	2,65
50x32x50	192206555	2,72
50x40x50	192206545	2,79
63x25x63	192206979	5,11
63x32x63	192206959	5,11
63x40x63	192206949	5,11
63x50x63	192206969	5,11
75x50x75	192206253	9,84



CODO 45°









20	192204100	0,21
25	192204200	0,40
32	192204300	0,61
40	192204400	1,15
50	192204500	1,89
63	192204600	3,77
75	192204575	5,79
90	192204590	9,92
110	PPR.C45110	15,48



REDUCCIÓN  
M-H

20-16	192202016	0,29
25-20	192202210	0,33
32-25	192202320	0,35
40-20	192204020	0,44
40-25	192204025	0,52
40-32	192202430	0,64
50-25	192205025	0,83
50-32	192205032	0,91
50-40	192202540	1,02
63-20	192202632	1,65
63-32	192206332	1,47
63-40	192206340	1,47
63-50	192202650	1,64
75-50	192207550	2,71
75-63	192202760	4,29
90-63	192209063	4,66
90-75	192209075	5,49
110-90	192211090	9,00

POLIPROPILENO (PP-R)

MEDIDA			REF.	€	MEDIDA			REF.	€
	20 x 1/2"	192201110	2,08		20	192288520	5,37		
	20 x 3/4"	192201120	3,07		25	192288525	7,89		
	25 x 1/2"	192201210	2,12		32	192288532	13,06		
	25 x 3/4"	192201220	2,99		40	192288540	25,24		
	32 x 3/4"	192201323	3,93		50	192288550	33,99		
	32 x 1"	192203330	5,83		63	192288563	52,98		
	40x 1 1/4"	192203440	10,36		75	192288575	77,55		
	50x 1 1/2"	192203550	13,01						
	63 x 2"	192203660	19,57						
	75x 2 1/2"	192203770	43,02						
<b>ENTROQUE R/H</b>				<b>VÁLVULA BOLA</b>					
	20 x 1/2	192205110	2,15		20 x 1/2"	192259202	5,85		
	25 x 1/2	192205210	2,29		20 x 3/4"	192259203	6,57		
	25 x 3/4	192205220	3,16		25 x 1/2"	192259252	6,18		
	32 x 3/4	192205323	4,22		25 x 3/4"	192259253	7,79		
	32 x 1"	192205330	6,40		25 x 1"	192259254	7,90		
					32 x 1"	192259324	11,69		
			40 x 1" 1/4		192259405	23,38			
			50 x 1" 1/2		192259506	35,08			
			63 x 2"		192259637	65,98			
<b>CODO R/H</b>					<b>RACOR LOCO</b>				
	16 x 1/2	192202162	3,07		50	192268050	1,35		
	20 x 1/2	192202110	2,33		63	192268063	1,82		
	20 x 3/4	192202120	3,48		75	192268075	3,63		
	25 x 1/2	192202211	2,41		90	192268090	5,31		
	25 x 3/4	192202220	3,44		110	192268110	8,42		
	32 x 1"	192214330	7,79						
	40 x 1" 1/4	192214440	13,66						
	50 x 1" 1/2	192214550	17,04						
	63 x 2"	192214630	28,05						
	75 x 2" 1/2	192214758	54,12						
90 x 3"	192214759	90,11							
<b>ENROQUE R/M</b>				<b>PORTA BRIDA</b>					
	65	028524947	4,35		50	192269050	14,80		
	80	028524948	4,90		63	192269063	19,13		
	100	028524949	6,30		75	192269075	22,87		
	125	028524950	7,85		90	192269090	24,52		
	150	028524951	10,70		110	192269110	28,45		
<b>JUNTA PLANA</b>				<b>BRIDA ACERO</b>					
	20 x 1/2	192207111	2,35						
	25 x 1/2	192207212	2,53						
	25 x 3/4	192207222	3,26						
	32 x 3/4	192207323	4,66						
<b>TE R/H</b>									

**POLIETILENO METAL PN 25**

		MEDIDA	REF.	€			MEDIDA	REF.	€
<p>MANGUITO DOBLE BRIDAS</p>		20 x 20	022283074	5,24	<p>CODO MACHO</p>		1/2" x 20	022283117	4,22
		25 x 25	022283075	6,90			3/4" x 25	022283118	6,07
		32 x 32	022283076	10,77			1" x 32	022283119	10,67
		40 x 40	022283077	17,86			1 1/4"x40	022283120	15,20
		50 x 50	022283078	25,66			1 1/2"x50	022283121	25,72
		63 x63	022283079	42,84			2" x 63	022283122	38,01
		75 x 75	022268080	102,28					
<p>MANGUITO MACHO BRIDAS</p>		1/2" x 20	022283062	3,16	<p>CODO HEMBRA BRIDAS</p>		1/2" x 20	022283126	4,10
		3/4" x 25	022283063	4,59			3/4" x 25	022283127	5,84
		1" x 32	022283064	7,16			1" x 32	022283128	9,63
		1 1/4"x40	022283065	11,22			1 1/4"x40	022283129	14,46
		1 1/2"x50	022283066	16,08			1 1/2"x50	022283130	28,62
		2" x 63	022283067	25,80			2" x 63	022283131	39,21
		2 1/2x75	022268075	58,50			2 1/2x75	022268091	90,53
	3" x 90	022268076	97,40						
<p>MANGUITO HEMBRA BRIDAS</p>		1/2" x 20	022283050	3,36	<p>CODO PLACA</p>		20 x 1/2	022283202	4,31
		3/4" x 25	022283051	4,75			25 x 3/4	022283225	6,46
		1" x 32	022283052	6,94	<p>TE IGUAL BRIDAS</p>		20x20x20	022283092	8,18
		1 1/4"x40	022283053	10,84			25x25x25	022283093	12,64
		1 1/2"x50	022283054	16,52			32x32x32	022283094	18,59
	2" x 63	022283055	26,68		40x40x40	022283095	28,58		
	2 1/2x75	022268070	61,21		50x50x50	022283096	46,36		
<p>CODO BRIDAS</p>		20 x 20	022284200	5,92	<p>TE HEMBRA BRIDAS</p>		20 x 1/2" x 20	022283104	6,37
		25 x 25	022284201	9,13			25 x 3/4" x 25	022283105	10,19
		32 x 32	022284202	13,40			32 x 1" x 32	022283106	15,18
		40 x 40	022284203	21,13			40 x 1 1/4" x 40	022283107	24,38
		50 x 50	022284204	35,40			50 x 1 1/2" x 50	022283108	38,16
		63 x63	022284205	53,32			63 x 2" x 63	022283109	64,95
		75 x 75	022268085	143,25			75 x 2 1/2 x 75	022268097	219,88

**POLIETILENO BARRA**

		MEDIDA	REF.	€/Metro			MEDIDA	REF.	€/Metro	
<p>ALIMENTARIO PE 100</p>		20x20 Atm	4 mts.	621120020	1,25	<p>* Barras de 6 mts.</p>				
		25x20 Atm	4 mts.	621120025	2,00			Atm		
		32x16 Atm		621116032	1,91			90x16	621116090	15,06
		40x16 Atm		621116040	3,07			110x16	621116110	21,36
		50x16 Atm		621116050	4,71			125x16	621116125	27,60
		63x16 Atm		621116063	7,46			160x16	621116160	45,16
		75x16Atm		621116075	10,40			200x16	621116200	70,37

## POLIETILENO PLASTICO (FITTING)

	□	MEDIDA	REF.	€		□	MEDIDA	REF.	€
	40	20 x 1/2"	460824320	2,37		25	20 x 1/2"	460890012	5,00
	50	25 x 3/4"	460824325	2,97		30	25 x 3/4"	460890034	5,74
	25	32 x 1"	460824332	4,75		20	32 x 1"	460890001	7,24
	15	40 x 1 1/4"	460824340	6,35		25	40 x 1 1/4"	460890114	9,04
	10	50 x 1 1/2"	460824350	8,49		15	50 x 1 1/2"	460890112	13,52
	9	63 x 2"	460824363	12,87		12	63 x 2"	460890002	16,58
5	75 x 2 1/2"	460824375	22,67						
	25	20 x 1/2"	460827020	2,91		35	20	460890020	3,84
	25	25 x 3/4"	460827025	3,68		45	25	460890025	4,65
	10	32 x 1"	460827032	4,86		25	32	460890032	6,80
	16	40 x 1 1/4"	460827040	6,71		15	40	460890040	10,36
	10	50 x 1 1/2"	460827050	9,25		15	50	460890050	14,97
	15	63 x 2"	460827063	13,74		8	63	460890063	22,53
5	75 x 2 1/2"	460827075	24,60	5	75	460890075	40,07		
					5	90	460890090	66,71	
	50	20	460824020	3,84		25	20	460813020	5,82
	50	25	460824025	4,65		25	25	460813025	6,98
	16	32	460824032	6,60		8	32	460813032	9,93
	20	40	460824040	10,36		20	40	460813040	15,49
	15	50	460824050	14,97		10	50	460813050	22,61
	6	63	460824063	22,57		5	63	460813063	34,01
5	75	460824075	38,82	5	75	460813075	66,71		
5	90	460824090	64,67	5	90	460813090	100,94		
	12	25 x 20	460824001	4,65		20	20	460829020	3,09
	10	32 x 25	460824002	6,63		25	25	460829025	3,46
	25	40 x 32	460824003	10,36		32	32	460829032	5,38
				40		40	460829040	6,68	
	20	20 x 1/2"	460892020	3,86		15	20 x 1/2"	460813012	4,88
	12	25 x 3/4"	460892025	4,73		20	25 x 3/4"	460813034	6,86
	20	32 x 1"	460892032	6,00		9	32 x 1"	460813001	9,45
	25	40 x 1 1/4"	460892040	7,82		25	40 x 1 1/4"	460813114	12,27
	15	50 x 1 1/2"	460892050	10,67		15	50 x 1 1/2"	460813112	17,79
	10	63 x 2"	460892063	16,25		4	63 x 2"	460813002	27,94
3	75 x 2 1/2"	460892075	32,47	5	75 x 2 1/2"	460813212	49,16		
	-	1/2	460828002	0,80		20	20 x 1/2"	460847120	6,32
	100	3/4	460828003	1,26		10	25 x 3/4"	460847125	6,98
	100	1"	460828004	1,77		-	32 x 1"	460847132	9,93
	100	3/4 x 1/2	460828032	1,26		60	M3/4xH1/2	460828134	1,46
	100	1" x 3/4	460828043	1,77		100	M1"xH3/4	460828143	1,77

## TUBERÍA POLIETILENO (Rollo)



ALIMENTARIO

	MEDIDA	REF.	€/Metro	
	20 x 10 atm.	PE40	621210020	1,29
	25 x 10 atm.	PE40	621210025	2,02
	32 x 10 atm.	PE40	621210032	3,18
	40 x 10 atm.	PE100	621210040	2,07
	50 x 10 atm.	PE100	621210050	3,23
	63 x 10 atm.	PE100	621210063	5,10
	75 x 10 atm.	PE100	621210075	7,19
	90 x 10 atm.	PE100	621210090	10,33

## POLIETILENO ELECTROSOLDABLE

		MEDIDA	REF.	€			MEDIDA	REF.	€
		40	028512095	9,82					
		50	028512097	12,86			500 ml	040420510	5,73
		63	028512099	13,69					
		75	028512101	22,86					
		90	028512103	23,57					
		110	028512105	33,45					
		40	028512094	9,82			63 x 40	028515390	8,69
		50	028512096	12,59			63 x 50	028512072	8,69
		63	028512098	13,69			75 x 63	028515563	12,06
		75	028512100	22,86			90 x 63	028515392	15,42
		90	028512102	23,57			110 x 90	028515693	21,55
		110	028512104	33,45					
		40	028512162	11,01			63	028513063	5,77
		50	028512163	12,38			75	028513075	6,96
		63	028512164	14,05			90	028513090	7,09
		75	028512165	23,99			110	028513110	8,89
		90	028512166	24,40					
		110	028512167	41,37					
		40	028512663	3,31			DN 65 (2 1/2")	028524008	67,90
		50	028512664	4,27			DN 80 (3")	028524017	69,27
		63	028512665	4,59			*DN 100 (4")	028524010	89,00
		75	028512666	8,74			*DN 125 (5")	028524011	66,05
		90	028512667	9,17			*DN 150 (6")	028524012	83,35
		110	028512668	11,41					
		125	028512669	15,89					
		160	028512670	23,73					
		200	028512671	41,19					
		32 x 1"	028516152	20,34			65	028524947	4,35
		40 x 1 1/4"	028516153	27,56			80	028524948	4,90
		50 x 1 1/2"	028516154	34,78			100	028524949	6,30
		63 x 2"	028516155	45,93			125	028524950	7,85
		75 x 2 1/2"	028516151	83,66			150	028524951	10,70
		32 x 1"	028516156	20,34			M-16x60	028524811	2,59
		40 x 1 1/4"	028516157	27,56			M-16x80	028524812	3,26
		50 x 1 1/2"	028516158	34,78			M-16x110	028524814	4,31
		63 x 2"	028516159	45,93			M-16x130	028524815	4,86
		75 x 2 1/2"	028516160	83,66					
		65	028504103	64,90			028524810	0,44	
		80	028504104	71,73					
		100	028504105	92,00					
		125	028504106	127,41					



# Solución C-80

Portarrollo con llave de escuadra













REF. 12010080



## POLIBUTILENO

MEDIDA			REF.	€	MEDIDA			REF.	€
 <p>TUBERÍA ROLLO (25mts)</p>				15	628016022	93,99	 <p>MANDO OCULTO</p>		
				22	628016025	155,35			
 <p>TUBERÍA BARRA (6 mtrs.)</p>				15	628026001	22,68	 <p>MANDO PALANCA</p>		
				22	628026003	38,25			
 <p>VALV. ESF. EMP. "U"</p>				15	028060420	19,58	 <p>MANDO TRIANGULAR</p>		
				22	028060421	27,58			
 <p>VALV. ESF. EMP.</p>				15	028060410	24,69	 <p>CASQUILLO</p>		
				22	028060412	27,55			
 <p>VALV. ESF. PALANCA</p>				22	028060267	0,38	 <p>SOPRTE DISTANCIADOR</p>		
				15	028060400	24,70			
 <p>VALV. ESF. PALANCA</p>				22	028060402	27,70			

## POLIBUTILENO

	MEDIDA	REF.	€		MEDIDA	REF.	€
 <p>CODO 90° HH</p>	16	028060051	3,80	 <p>CODO R/H</p>	15 - 1/2	028060240	9,66
	22	028060052	4,83		22 - 1/2	028060241	11,54
						22 - 3/4	028060249
 <p>TAPÓN H</p>	15	028060216	3,17	 <p>MANGUITO R/M</p>	15 x 1/2	028060132	7,54
					22 x 1/2	028060131	10,19
					22 x 3/4	028060133	8,93
 <p>MANGUITO RECTO HH</p>	15	028060041	3,12	 <p>CODO PLACA</p>	15 x 1/2	028060245	11,16
	22	028060042	4,22		22 x 1/2	028060246	14,83
 <p>TE REDUCIDA</p>	22.15.15	028060086	7,00		 <p>MANGUITO R/H</p>	15 x 1/2	028060142
	22.22.15	028060071	7,56	22 x 3/4		028060144	10,53
	22.15.22	028060076	7,14				
	15.22.15	028060090	7,67				
 <p>TE IGUAL</p>	15	028060066	5,58	 <p>TE R/H</p>	15 x 1/2	028060252	13,55
	22	028060067	7,29		22 x 1/4	028060253	15,03

## HIERRO

	MEDIDA	REF.	€		MEDIDA	REF.	€
	3/8"	021800901	3,01		1/2"	021800922	2,43
	1/2"	021800902	1,89		3/4"	021800923	2,93
	3/4"	021800903	2,65		1"	021800924	4,90
	1"	021800904	4,11		1 1/4"	021800925	9,33
	1 1/4"	021800905	7,53		1 1/2"	021800926	12,60
	1 1/2"	021800906	9,70		2"	021800927	18,16
	2"	021800907	14,83		2 1/2"	021800928	58,33
	2 1/2"	021800908	50,30		3"	021800929	87,19
	3"	021800909	77,04				
	3/8"	021802701	2,84		1/2"	021803402	11,31
	1/2"	021802702	1,86		3/4"	021803403	13,88
	3/4"	021802703	2,30		1"	021803404	16,74
	1"	021802704	3,88		1 1/4"	021803405	23,79
	1 1/4"	021802705	5,45		1 1/2"	021803406	30,85
	1 1/2"	021802706	7,34		2"	021803407	43,45
	2"	021802707	11,81		2 1/2"	021803408	101,71
	2 1/2"	021802708	40,99		3"	021803409	149,71
	3"	021802709	53,20				
4"	021802711	108,23					
	3/8"	021802801	3,44		3/8"	021803411	13,35
	1/2"	021802802	1,94		1/2"	021803412	12,63
	3/4"	021802803	2,23		3/4"	021803413	16,23
	1"	021802804	3,05		1"	021803414	19,98
	1 1/4"	021802805	5,83		1 1/4"	021803415	27,10
	1 1/2"	021802806	7,28		1 1/2"	021803416	36,70
	2"	021802807	11,69		2"	021803417	51,56
	2 1/2"	021802808	35,43		2 1/2"	021803418	130,44
	3"	021802809	55,08		3"	021803419	210,93
	3/8"	021802901	1,96		3/8"	021803001	2,38
	1/2"	021802902	1,43		1/2"	021803002	2,30
	3/4"	021802903	1,94		3/4"	021803003	2,89
	1"	021802904	2,48		1"	021803004	3,66
	1 1/4"	021802905	4,91		1 1/4"	021803005	6,81
	1 1/2"	021802906	6,60		1 1/2"	021803006	7,96
	2"	021802907	10,03		2"	021803007	13,10
	2 1/2"	021802908	23,60		2 1/2"	021803008	29,73
	3"	021802909	29,93		3"	021803009	33,55
	3/8"	021802901	1,96		3/8"	021801301	4,21
	1/2"	021802902	1,43		1/2"	021801302	2,65
	3/4"	021802903	1,94		3/4"	021801303	3,93
	1"	021802904	2,48		1"	021801304	5,89
	1 1/4"	021802905	4,91		1 1/4"	021801305	10,94
	1 1/2"	021802906	6,60		1 1/2"	021801306	14,33
	2"	021802907	10,03		2"	021801307	21,66
	2 1/2"	021802908	23,60		2 1/2"	021801308	74,34
	3"	021802909	29,93		3"	021801309	87,19
				4"	021801310	156,69	
	1/2 x 3/8"	021804021	3,15		1/2 x 3/8"	021804121	1,96
	3/4" x 1/2"	021804032	3,44		3/4" x 1/2"	021804132	2,04
	1 x 1/2"	021804042	4,80		1 x 1/2"	021804142	3,11
	1 x 3/4"	021804043	4,45		1 x 3/4"	021804143	3,11
	1 1/4 x 1/2"	021804052	10,60		1 1/4 x 1/2"	021804152	5,20
	1 1/4 x 3/4"	021804053	8,50		1 1/4 x 3/4"	021804153	5,14
	1 1/4 x 1"	021804054	8,50		1 1/4 x 1"	021804154	4,80
	1 1/2 x 1/2"	021804062	14,55		1 1/2 x 1/2"	021804162	6,75
	1 1/2 x 3/4"	021804063	13,70		1 1/2 x 3/4"	021804163	7,13
	1 1/2 x 1"	021804064	9,86		1 1/2 x 1"	021804164	5,73
	1 1/2 x 1 1/4"	021804065	10,25		1 1/2 x 1 1/4"	021804165	5,61
	2 x 1"	021804074	20,24		2 x 1/2"	021804172	14,55
	2 x 1 1/4"	021804075	18,36		2 x 3/4"	021804173	14,05
2 x 1 1/2"	021804076	16,03	2 x 1"	021804174	10,64		
2 1/2 x 1 1/2"	021804086	54,15	2 x 1 1/4"	021804175	9,86		
2 1/2 x 2"	021804087	47,11	2 x 1 1/2"	021804176	9,86		
3 x 2"	021804097	70,20	2 1/2 x 1 1/2"	021804186	29,99		
3 x 2 1/2"	021804098	70,20	2 1/2 x 2"	021804187	28,60		
				3 x 2"	021804197	35,64	
				3 x 2 1/2"	021804198	35,80	



Almacén de Fontanería











**FINANCIA  
MAQUINARIA  
Y/O  
HERRAMIENTA**



**DESDE 52€/mes, EN SOLO 24 MESES**

**PARA MÁS INFORMACIÓN, CONSULTE A SU  
AGENTE COMERCIAL O PUNTO DE VENTA**











## GEBO

MEDIDA			REF.	€	MEDIDA			REF.	€
 <p>TIPO O MANGUITO</p>	3/8"	380620001	14,41	 <p>TIPO T TÉ ROSCA HEMBRA</p>	1/2"	380880081	15,93		
	1/2"	380620002	14,41		3/4"	380880082	18,85		
	3/4"	380620003	18,12		1"	380880083	22,44		
	1"	380620004	20,85		1 1/4"	380880084	30,01		
	1 1/4"	380620005	26,16		1 1/2"	380880085	35,98		
	1 1/2"	380620006	34,46		2"	380680086	55,70		
	2"	380620007	52,51						
 <p>TIPO OF MANGUITO BRIDA</p>	2 1/2"	380620008	108,24	 <p>TAPAPOROS DC CORTO ACERO</p>	1/2"	380418201	7,25		
	3"	380620009	126,83		3/4"	380418202	7,89		
	4"	01.220.02.09	268,58		1"	380418203	10,50		
					1 1/4"	380418204	13,19		
			1 1/2"		380418205	16,15			
			2"		380418206	21,37			
			2 1/2" DS		380418007	39,92			
			3"		380418208	38,98			
			4"		380418209	55,13			
 <p>TIPO A ROSCA MACHO</p>	3/8"	380631001	11,02		 <p>TIPO I ROSCA HEMBRA</p>	3/8"	380632001	11,15	
	1/2"	380631002	11,02	1/2"		380632002	11,15		
	3/4"	380631003	12,35	3/4"		380632003	12,55		
	1"	380631004	13,94	1"		380632004	14,01		
	1 1/4"	380631005	19,52	1 1/4"		380632005	19,92		
	1 1/2"	380631006	23,70	1 1/2"		380632006	23,83		
	2"	380631007	33,26	2"		380632007	34,99		
 <p>TIPO OF MANGUITO BRIDA</p>	2 1/2"	380631008	65,18	 <p>TIPO OF MANGUITO BRIDA</p>		2 1/2"	380632008	71,81	
	3"	380631009	88,74			3"	380632009	93,04	
	4"	380631010	179,72			4"	380632010	182,66	















## TUBERIA DE HIERRO

MEDIDA			REF.	€/mts NETO	MEDIDA			REF.	€/mts NETO
 <p>TUBERIA DE HIERRO</p>	1/2"	622011111	4,55	1 1/2"	622011115	8,67			
	3/4"	622011112	3,95	2"	622011116	12,05			
	1"	622011113	7,85	2 1/2"	622011117	14,67			
	1 1/4"	622011114	7,59	3"	622011118	20,15			

## GEBO

MEDIDA			REF.	€	MEDIDA			REF.	€
 <p><b>ABRAZADERA C/ Toma</b></p>	1/2"x1/2"	380419201	8,26	 <p><b>RACOR CU / Rosca Macho</b></p>	15 x 1/2"	381034062	16,92		
	3/4"x1/2"	380419202	9,63		18 x 1/2"	381034092	23,91		
	1"x1/2"	380419203	12,11		22 x 3/4"	381034043	27,74		
	1"1/2x3/4"	380419204	17,60						
 <p><b>TAPAPOROS COBRE</b></p>	12	381019012	6,38	 <p><b>COLLARÍN CU/ Toma</b></p>	15 x 1/2"	381019962	12,83		
	15	381019015	9,24		18 x 1/2"	381019992	13,27		
	18	381019018	9,55		22 x 3/4"	381019942	14,01		
	22	381019022	11,90		28 x 3/4"	381019943	19,53		
	28	381019028	15,32						
 <p><b>TAPAPOROS PLÁSTICOS</b></p>	16	380622616	9,43	 <p><b>MANGUITO CU</b></p>	15	381022015	33,44		
	20	380622820	7,76		18	381022018	46,71		
	25	380622825	8,51		22	381022022	48,02		
	32	380622832	11,30						
	40	380622840	14,32						
	50	380622850	19,36						
	63	380622863	24,56						
	75	380622875	45,73						
 <p><b>ENLACE UNIVERSAL REPARACIÓN MULTIMATERIAL</b></p>	15-21	380255471	35,61	 <p><b>UNIFIX MAXI</b></p>	60-67	380660067	75,21		
	21-27	380255472	39,03		73-80	380673080	77,24		
	27-34	380255473	54,43		87-95	380687095	78,02		
	34-39	380255474	75,06		102-112	380610212	82,28		
	39-43	380255475	85,86		108-118	380610818	82,61		
	47-49	380255476	113,93						
	59-61	380255477	121,48						
 <p><b>COLLARÍN FUNDICIÓN AZUL PE/PVC</b></p>	63 x 1"	380116820	32,30	 <p><b>MULTIDIÁMETRO</b></p>	88-103	380688103	62,65		
	63 x 2"	380116826	34,95		108-128	380688128	64,31		
	75 x 1"	380116828	36,50		159-182	380688182	101,92		
	75 x 2"	380116834	38,05						
	90 x 1"	380116836	41,70						
	90 x 2"	380116842	44,25						
	110 x 1"	380116844	49,05						
	110 x 2"	380116850	50,20						
	125 x 1"	380116852	63,80						
	125 x 2"	380116858	66,80						
160 x 2"	380116870	85,15							

## FIJACIÓN, SELLANTES, CLAVADO Y PERFORACIÓN

		□ MEDIDA	REF.	€/mtr.			□ MEDIDA	REF.	€
 <p>ABRAZADERA DOBLE M6</p>	100	12	300260312	0,43	 <p>ISOFÓNICA DOBLE</p>	50	15	300260060	0,92
	100	15	300260316	0,47		50	18	300260061	0,98
	100	18	300260320	0,52		25	22	300260062	1,26
	50	22	300260322	0,59		25	28	300260068	1,57
	25	28	300260328	0,68					
 <p>ABRAZADERA M6</p>	100	10	300260810	0,26	 <p>ABRAZADERA ISOFONICA M6 SIMPLE</p>	100	12	300260012	0,40
	100	12	300260812	0,26		100	15	300260015	0,46
	100	15	300260815	0,27		100	18	300260018	0,48
	100	16	300260816	0,28		100	22	300260022	0,52
	100	18	300260818	0,29		100	28	300260028	0,60
	100	20	300260820	0,30		50	32	300260032	0,71
	100	22	300260822	0,31		50	35	300260035	0,76
	100	25	300260826	0,32		50	40	300260040	0,98
	100	28	300260828	0,34		50	42	300260042	1,00
	50	32	300260832	0,38		50	50	300260050	1,22
	50	35	300260835	0,44		50	54	300260054	1,34
	50	40	300260840	0,47					
	50	42	300260842	0,48					
	50	50	300260850	0,59					
	50	54	300260854	0,71					
	50	63	300260863	0,80					
	 <p>SIN FIN</p>	200	8-16	300210516		0,42	 <p>GASMICA</p>	100	12
200		12-20	300210520	0,43	100	15		300260115	0,55
200		16-25	300210525	0,45	100	18		300260118	0,57
200		20-32	300210532	0,47	100	22		300260122	0,61
100		25-40	300210540	0,52	100	28		300260128	0,65
50		32-50	300210550	0,56	50	35		300260135	0,80
50		40-60	300210560	0,66	50	42		300160142	0,88
25		100-120	300210592	1,17					
25		110-130	300210593	1,23					
 <p>ALCAYATA (2 uds)</p>		4,5 x 60	300254560	1,82	 <p>CLIP DOBLE M6</p>	50		12	300261612
	8 x 65	300250865	1,18	50		14-15	300261615	0,53	
 <p>TIRAFONDO DOBLE ROSCA</p>	100	M.8 x 80	300230880	0,27	 <p>CLIP M6</p>	100	12	300261412	0,29
	100	M.8 x 100	300230810	0,33		100	14-15	300261415	0,32
	50	M.10x100	300231010	0,57		100	16-18	300261418	0,40
	50	M.10x110	300231110	0,58		100	20-22	300261422	0,41
 <p>TUERCA HEXAGONAL</p>	200	M.6	300291006	0,03	 <p>MULTITODO</p>	100	15-18	300232915	0,31
	200	M.8	300290238	0,07		50	20-25	300232920	0,37
	100	M.10	300291010	0,21		50	25-32	300232925	0,49
	100	M.12	300291012	0,30					
 <p>ARANDELA</p>	200	M.6	300293006	0,08	 <p>TIRAFONDO ABRAZADERA</p>	100	M-6 x 30	300260870	0,10
	200	M.8	300293008	0,17		100	M-8 x 40	300280150	0,28
	200	M.10	300293010	0,43					
	50	M.12	300292012	0,19					

## FIJACIÓN, SELLANTES, CLAVADO Y PERFORACIÓN

REFORZADA HIERRO M8-M10				ABARCÓN					
	MEDIDA	REF.	€/mtr.		MEDIDA	REF.	€		
	50	1/2"	300280443	0,86		50	1"	300214235	0,63
	50	3/4"	300280444	0,92		50	1 1/4"	300214242	0,70
	50	1"	300280445	0,98		30	1 1/2"	300214248	1,31
	50	1 1/4"	300280447	1,08		30	2"	300214260	1,43
	25	1 1/2"	300280448	1,21		20	2 1/2"	300214275	1,95
	25	2"	300280449	1,34		20	3"	300214290	2,10
	25	2 1/2"	300280500	1,36					
	25	3"	300280502	1,50					
	25	4"	300280503	1,70					
	25	5"	300280504	2,23					
	25	6"	300280505	2,89					
INOXIDABLE M8				SOPORTES					
	50	*15	300216015	2,68		27x18x20cm	300200272	4,96	
	50	18	300209018	2,50		27x18x30cm	300200273	5,77	
	50	22	300209022	2,67		38x40x30cm	300200280	11,49	
	50	28	300209028	2,83		38x40x40cm	300200384	14,00	
	50	35	300209035	3,00		38x40x60cm	300200386	21,88	
	50	42	300209042	3,22					
	50	54	300209054	3,66					
	TIRAFONDOS INOX				TORNILLO BARRAQUERO				
	100	M-6 x 30	300204630	0,83		200	8 x 60	300240860	0,29
	100	M-8 x 50	300204850	1,69		100	8 x 80	300240880	0,36
(GOMA VERDE) PPR ISOFÓNICA M8 - M10				CINTA PERFORADA					
	50	20	300259020	1,78		300281350	8,84		
	50	25	300259025	1,96					
	50	32	300259032	2,32					
	50	40	300259040	2,56					
	25	50	300259050	3,30					
	25	63	300259063	4,48					
	25	75	300259075	4,77					
	25	90	300259090	5,05					
ABRAZADERA ISOFÓNICA M8 - M10				ABRAZADERA DE CIERRE NYLON					
	50	22	300281022	0,99		100	15	300211115	0,34
	50	28	300281028	1,09		100	18	300211118	0,39
	50	35	300281035	1,17		100	20	300211120	0,41
	50	40-42	300281040	1,27		100	22	300211122	0,42
	25	48-50	300281048	1,42		100	25	300211125	0,46
	25	54	300281054	1,50		50	28	300211128	0,58
	25	60	300281060	1,59		25	32	300211132	0,66
	25	75	300281075	1,81		25	35	300211135	0,78
	25	90	300281090	1,97		25	40	300211140	0,91
	25	110	300281110	2,52		25	50	300211150	1,24
	25	125	300281125	2,88					
	25	160	300281160	3,73					
	25	200	300281200	4,52					
	25	250	300281250	5,72					
	25	315	300281315	7,53					
PVC				GUÍ AMETÁLICA (2 metros)					
	25	75	300280975	2,21		20 x 10	300211399	6,50	
	25	90	300280990	2,20		28 x 30	300212830	20,06	
	25	110	300280110	2,18			38 x 40	300213840	30,33
	25	125	300280125	2,30				40 x 20	300214020
	25	160	300280160	3,38					
	20	200	300280200	4,21					
	20	250	300280250	7,51					
	-	315	300280315	10,30					



## FIJACIÓN, SELLANTES, CLAVADO Y PERFORACIÓN

□ MEDIDA REF. €/mtr.				MEDIDA REF. €										
<p><b>JUEGO TORNILLOS LAVABO</b></p>	M-10x110	300290210	2,92	<p><b>BRIDAS NYLON</b> (100 uds.)</p>	2,5x100	300281251	1,80							
					<p><b>JUEGO TRONILLOS TERMOS</b></p>	3,6x200	300281362	3,60						
			3,6x290			300281390	5,50							
			4,8x200			300281482	4,50							
			4,8x300			300281483	7,20							
			4,8x360			300281486	8,80							
			Taco brida	300281490	5,90									
				<p><b>TORNILLO WC LATERAL</b></p>	300290220	2,17								
					<p><b>TORNILLO WC VERTICAL</b></p>	300290232	1,99							
<p><b>HYDRAFIX</b></p>	300	6 x 30	300232506	13,23		<p><b>TORNILLO WC HORIZONTAL</b></p>	300290225	6,89						
	128	8 x 40	300232508	11,43	<p><b>MANGUITO HEXAGONAL</b></p>		250	M-6 x 20	300260302	0,31				
	75	10 x 50	300232510	13,23			100	M-8 x 20	300280308	0,50				
				<p><b>ANCLAJE HEMBRA</b></p>	100	M-8	300211400	0,19	<p><b>TEFLON Estrecho</b></p>	991380550	0,36			
					<p><b>TEFLON Ancho</b></p>	200	M-6 x 20	300260310		0,27	<p><b>CINTA ADHESIVA NEGRA</b></p>	20x19mm	040218437	1,53
						100	M-8 x 20	300280311		0,23		33x50mm	040218425	13,05
				<p><b>VARILLA</b></p>		M-6x1000	300290306	1,17	<p><b>ALUMINIO</b></p>	10x50mm		040218403	2,83	
					M-8x1000	300290308	1,80	50x50mm		040218439	6,98			
					M-10x1000	300290310	3,36	<p><b>BLANCA</b></p>		5x50mm	991304234	4,16		
					M-12x1000	300290312	4,90			50x50mm	991304235	8,40		
				<p><b>LOCTITE 55</b></p>	040619998	16,30								

## FIJACIÓN, SELLANTES, CLAVADO Y PERFORACIÓN

### Polímeros MS

Código	Descripción	Uds. Caja	PVP
040246004	POLÍMERO TOT MS-20 NEGRO 280 ML	25 U.	6,68
040246002	POLÍMERO TOT MS-20 BLANCO 280 ML	25 U.	6,68
040246003	POLÍMERO TOT MS-20 GRIS 280 ML	25 U.	6,68
040246009	POLÍMERO TOT MS-20 TEJA 280 ML	25 U.	6,68
040246801	POLÍMERO TOT MS CRISTAL 300 ML	12 U.	8,76
040246702	POLÍMERO MS RAPID BLANCO 300 ML	12 U.	7,10
040246202	POLÍMERO MS PISCINAS 280 ML		7,18



### Impermeabilizantes líquidos

Código	Descripción	Uds. Caja	PVP
040201301	IMPERMEABILIZANTE MS-6000 GRIS 1 KG	6 U.	18,17
040201401	IMPERMEABILIZANTE MS-6000 NEGRO 1 KG	6 U.	18,17
040201701	IMPERMEABILIZANTE MS-6000 BLANCO 1 KG	6 U.	18,17
040201901	IMPERMEABILIZANTE MS-6000 TEJA 1 KG	6 U.	18,17



### Siliconas Neutras

Código	Descripción	Uds. Caja	PVP
040242101	SILICONA NEUTRA UNIVER. TRNASL. 280 ML	25 U.	5,85
040242102	SILICONA NEUTRA UNIVER. BLANCA 280 ML	25 U.	5,85



### Spray Ignifugo

Código	Descripción	Uds. Caja	PVP
991310904	COLLAK FIRETEC 750 ML		15,10

### Siliconas Ácidas

Código	Descripción	Uds. Caja	PVP
991380210	SILICONA FYCE TRANSLUCIDO 280 ML	25 U.	4,14
991380211	SILICONA FYCE BLANCO 280 ML	25 U.	4,14



### Espumas de Poliuretano

Código	Descripción	Uds. Caja	PVP
991310388	FOAM PISTOLA 750 ML.	12 U.	8,61
991310386	ESPUMA MANUAL 300 ML.	12 U.	5,87



### Lubricante Multiusos

Código	Descripción	Uds. Caja	PVP
991307911	COLLAK ACEITE MULTIUSOS SPRAY 400ml	12 U.	5,40
423060000	STARRETT LUBRIC. MULTIUSO SPRAY 200ml	24 U.	6,42



### Taco Químico

Código	Descripción	Uds. Caja	PVP
040248603	TACO QUIMICO		12,87
040233047	BOLSA TAMICES 9x50		5,03
040233048	BOLSA TAMICES 13x85		5,03
040233046	CANULA MEZCLADORA		0,74



### Pistolas Silicona











Código	Descripción	Uds. Caja	PVP
420407612	PISTOLA SILICONA		6,26
420407613	PISTOLA SILICONA PROFESIONAL		20,71



## VARIOS FONTANERÍA

MEDIDA			REF.	€	MEDIDA			REF.	€				
 <p><b>JUNTAS</b></p>					3/8	480470050	0,10	 <p><b>ATOMIZADORES</b></p> <p>*Llave Atomizadores</p> <p>(Lavabo) M 24/100</p> <p>(Lavabo) H 22/100</p> <p>(Baño) M 28/100</p> <p>Con rótula</p> <p>HRMBRA</p> <p>MACHO</p>			240558097	10,98	
					1/2	480470051	0,10				991305907	1,54	
					3/4	480470052	0,10				991305905	1,44	
					1"	480470053	0,10				991305906	1,83	
					1 1/4	480470054	0,20						
					1 1/2	480470055	0,20						
					2"	480470056	0,20						
					ANCHA 1/2	480470062	0,10						
ANCHA 3/4	480470063	0,10											
ANCHA 1"	480470064	0,10											
 <p><b>DESATASCADOR PROFESIONAL</b></p>					1 L	991328888	11,50	 <p><b>GOMAS</b></p> <p>1 Enxufe 25</p> <p>2 Enxufe 30</p> <p>3 victoria</p> <p>4 Lucerna Larga</p>			480450025	1,21	
					1 L	991328889	7,18				480450030	1,31	
 <p><b>DESATASCADOR DOMÉSTICO</b></p> <p><b>CABLE SIERRA</b></p>						991322735	16,49	 <p><b>JUNTA SEMICÓNICA</b></p>			480450032	1,66	
											480450031	1,39	
 <p><b>DENSO</b></p>					Bote	991322730	11,70	 <p><b>ARANDELA HIERRO</b></p>			3/8	480480048	0,75
											1/2	480480049	0,75
 <p><b>Epofix 500 gr.</b></p> <p><b>Epofix 114 gr.</b></p>						991322731	13,36	 <p><b>BOLA NYLON</b></p>			3/4	991300201	0,32
											1"	991300202	0,49
 <p><b>Tubo 200 gr.</b></p>						991308121	9,32	 <p><b>JUNTA PLANA</b></p>			1 1/4	991300203	0,58
											1 1/2	991300206	0,75
 <p><b>CAÑAMO</b></p>					Madeja	991322740	6,44	 <p><b>VÁLVULA FLOTADOR QUICK STOP</b></p>			2"	991300204	1,07
					Bote 80gr.	991310906	2,82				 <p><b>FLOTADOR GUIA</b></p>		
													
											1"	390633006	37,84
											1 1/4	390633010	73,32
											1 1/2	390633011	87,40
											2"	390633012	135,74
											2 1/2	390633013	813,44

## VARIOS FONTANERÍA

MEDIDA			REF.	€	MEDIDA			REF.	€
 <p>MONTURA UNIVERSAL VISTA</p>	16/150	991365502	9,43	 <p>MANGUITO ELECTRÓLISIS</p>	M-H	1/2	991365002	2,92	
	17/150	991365512	10,19		M-H	3/4	991365003	4,19	
	18/150	991365522	10,19		1	991365004	6,53		
	19/150	991365532	10,19		1" 1/4	991365005	19,50		
	20/150	991365542	10,19		1" 1/2	991365006	31,25		
	21/150	991365552	10,19		2"	991365007	44,03		
	22/150	911365562	10,19		 <p>LAVADORA TUBO CARGA</p>	2 mts.	991360760	9,04	
	23/150	991365572	7,34			1,5 mts.	991360759	7,67	
	3/8	991365582	10,19			 <p>LAVADORA TUBO DESCARGA</p>	991360761		5,27
	1/2	991365592	10,19				 <p>VÁLVULA SEGURIDAD TERMO (10kg)</p>	1/2	100100291
 <p>MONTURA UNIVERSAL EMPOTRAR</p>	16/150	991365503	10,55	3/4	991390856			11,32	
	17/150	991365513	14,09	 <p>TACO SX PLUS caja</p>	*100 uds/caja 6x30			302368006	7,17
	18/150	991365523	14,09		*100 uds/caja 8x40			302368008	10,72
19/150	991365533	14,09	*50 uds/caja 10x50		302368010	10,24			
20/150	991365543	14,09	*25 uds/caja 12x60		302368012	8,81			
21/150	991365553	14,09	 <p>AEROSOL SPRAY MARCADOR</p>	 <p>TACO QUÍMICO</p>	12 x 85	302041901	0,41		
22/150	911365563	14,09			16 x 85	302041902	0,35		
23/150	991365573	10,84			TACO QUÍMICO		302350636	19,37	
3/8	991365583	13,67							
1/2	991365593	14,09							
3/4	991365505	15,12							
 <p>Spray Triple Protect. Impermeabilizante</p>	302035747		11,80						

## AIREADORES

	M-24	240817298	1,96	 <p>FLEXIBLE 22/24M</p>	240814698	4,80	
	*M-24	240817398	13,40		CON RÓTULA 22/24M	240814798	2,59
	H-22	240817198	1,96	 <p>CAJA BOX AIREADORES (21 Piezas)</p>	240814000		48,00
	*H-22	240817399	13,40				
M-24 INCLINABLE	240819398		6,01				

## CONEXIONES WC, Lavabos y Bidés

DESCRIPCIÓN	LARGO EN CENTÍMETROS											
	15		20		25		30		40		50	
	REF.	€	REF.	€	REF.	€	REF.	€	REF.	€	REF.	€
M 3/8 - H 3/8	1115	2,80	1120	2,94	1125	3,07	1130	3,22	1140	3,55	1150	3,89
H 3/8 - H 3/8	2115	2,80	2120	2,94	2125	3,07	2130	3,22	2140	3,55	2150	3,89
M 1/2 - H 1/2	1215	3,17	1220	3,34	1225	3,46	1230	3,62	1240	3,89	1250	4,29
H 1/2 - H 1/2	2215	3,17	2220	3,34	2225	3,46	2230	3,62	2240	3,89	2250	4,29
H 3/8 - H 1/2	2315	3,17	2320	3,34	2325	3,46	2330	3,62	2340	3,89	2350	4,29

## CONEXIONES Termos y calentadores

DESCRIPCIÓN	LARGO EN CENTÍMETROS											
	15		20		25		30		40		50	
	REF.	€	REF.	€	REF.	€	REF.	€	REF.	€	REF.	€
M 1/2 - H 1/2	-	-	2212	10,65	2512	7,85	2355	8,16	2356	8,53	2357	9,38
H 1/2 - H 1/2	-	-	-	-	2513	7,85	3330	8,16	4013	8,53	3350	9,38
H 3/4 - H 3/4	-	-	4021	13,03	4022	9,18	4015	9,47	4018	9,85	4020	10,72
H 3/4 - H 3/4	-	-	3237	12,92	3238	9,18	4016	9,47	3240	9,85	4050	10,72

## CONEXIONES Grupos de Presión

DESCRIPCIÓN	LARGO EN CENTÍMETROS											
	15		20		25		30		40		50	
	REF.	€	REF.	€	REF.	€	REF.	€	REF.	€	REF.	€
H 3/4 - H 3/4							6060	15,44	6070	16,74	6080	18,44
M 3/4 - H 3/4	-	-					6030	15,44	6040	16,74	6050	18,44
M 1 - H 1	-	-	6124	5,33	6125	5,71	6130	18,44	6140	21,25	6150	24,62
M 1"1/4 - H 1"1/4									6240	49,53	6250	55,16
M 1"1/2 - H 1"1/2									6340	77,23	6350	84,96
M 2" - H 2"									6440	107,44	6450	114,72

## CONEXIONES Grifería

	MEDIDA	REF.	€	
	Cuello corto	10 X 100	240602011	2,93
	Cuello largo	10 x 100	240602012	3,81

## CONEXIONES INOXIDABLES Extensibles

	MEDIDA	REF.	€
	H-H 3/8 30 cm	240503830	7,05
	H-H 3/8 40 cm	240503840	7,37
	H-H 3/8 50 cm	240503850	7,86

## KIT CALDERAS MURALES

	REF.	€
	160951700	62,00

## CONEXIONES A MEDIA



MALETIN

REF.	€/rollo
6500	412,87

ROLLO 4 mts.



MEDIDA	REF.	€/rollo
1/2	240406546	53,30
3/4	240406552	66,73

TUERCAS MEDIDA	REF.	€
1/2	240406481	1,03
3/4	240406482	1,37

ANILLAS MEDIDA	REF.	€
1/2	240406486	0,76
3/4	240406487	0,82

JUNTAS MEDIDA	REF.	€
1/2	240406496	0,38
3/4	240406497	0,50

# Válvulas instaladas hace 1 año

sin

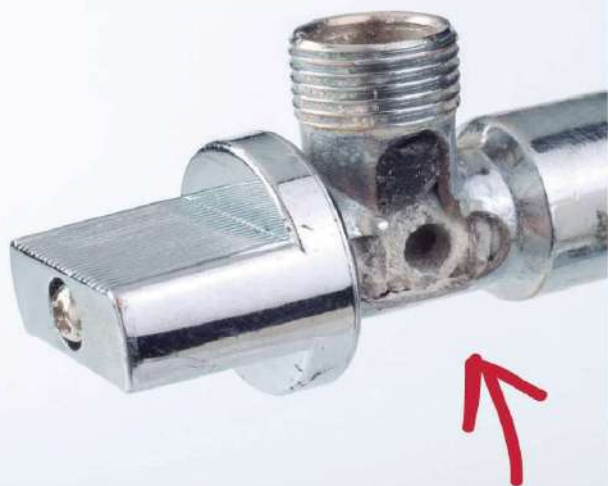

NO FUNCIONA

con **VITAQ<sup>®</sup>** SYSTEM A80 mac



FUNCIONA

Elige la gama **VITAQ System** para que tus instalaciones tengan **más vida** y estén **libres de cal**.  
ARCO vuelve a revolucionar la fontanería aportando un gran valor añadido a sus clientes.

**VITAQ<sup>®</sup>**  
SYSTEM

**15**  
AÑOS  
GARANTÍA



Elige calidad ARCO. No te la juegues.



made in  
**spain**  
original

**valvulasarco.com**

AGUA | GAS | CALEFACCIÓN

ARCO es una industria española con trayectoria familiar de más de 40 años de experiencia. Diseña, produce y distribuye válvulas y sistemas para fontanería, gas y calefacción. Su innovación, calidad y seguridad la sitúan como una marca internacional de referencia en el sector. Es miembro del Foro de Marcas Renombradas Españolas.

blog     

 **arco<sup>®</sup>**  
CALIDAD POR TRADICIÓN

## MECANISMOS WC

		MEDIDA	€			MEDIDA	€
	<p>1</p> <p>2</p> <p>1</p> <p>2</p>	DESCARGA 1 PULSADOR LOJA		<p>MECANISMOS FYCE</p> <p>MECANISMOS ALIMENTACIÓN DUAL ORIENTABLE DUO</p> <p>320170004</p> <p>19,47</p>			
		320170007	17,33				
		PULSADOR LOJA					
		320170008	3,70				
		DESCARGA DOBLE PULSADOR DENIA					
320170002	23,60						
GOMA CIERRE							
320170010	1,63						
<p>DESCARGA</p>	<p>1</p> <p>2</p>	TIFON 3G Un Pulsador interrumpible		<p>REF.</p> <p>3/8" 320412028 7,86</p>			
		320430701	14,01				
		TIFON 10 Un Pulsador					
		320429106	12,91				
		TIFON 4 Un Pulsador					
320430203	10,22						
				<p>GRIFO VERTICAL</p> <p>GRIFO LATERAL</p> <p>3/8" 320412024 5,38</p>			
<p>D/ PULSADOR 3G</p>	<p>1</p> <p>2</p> <p>1</p> <p>2</p>	DESCARGA D/PULSADOR (3G)		<p>JIMTEN ALIMENTACIÓN 2 en 1 LATERAL / INFERIOR</p> <p>461046500 19,62</p>			
		461028500	42,54				
		DESCARGA 1 PULSADOR(2L)					
		461028501	28,60				
		GOMA OBTURADORA					
461311256	1,71						
PULSADOR DOBLE							
461045255	14,16						
	<p>1</p> <p>2</p> <p>1</p> <p>2</p>	DESCARGA 1 PULSADOR ECO		<p>PRHIE ALIMENTACIÓN 2 en 1 LATERAL / INFERIOR</p> <p>320880120 20,08</p> <p>ALTIS 320880100 17,03</p> <p>FORTIS 320880101 17,03</p>			
		320870301	16,81				
		DESCARGA 1 PULS. NEGRO					
		320870302	16,81				
		PULSADOR NEGRO ECO					
320870303	15,74						
DESCARGA DOBLE PULSADOR NIAGARA							
320870300	29,96						

## MECANISMOS WC

MEDIDA			REF.	€	MEDIDA			REF.	€
1		2							
	1 Roca		320412012	1,33					
	2 Victoria (nuevo)		320412011	0,65					
	3 Tyfon		320413090	0,59					
	4 Porsan		320412010	1,00					
	GOMA OBTURADORA								
			81 x 55	320412540	1,53				
	JUNTA INODORO PEQ.								
			100 x 59	320412530	1,50				
	JUNTA INODORO								
			Pequeña	320611016	0,71				
			Grande	320611014	0,71				
	GOMA OBTURADORA								
	DESCARGADOR CISTERNA ALTA								
			DC 262	320611004	9,29				
			DC 026	320611002	2,09				
	CAMPANA CISTERNA ALTA								
				320611001	18,83				
	BOLSA MECANISMOS CISTERNA ALTA								
			9 litros	991310920	9,33				
			Bajante Cisterna	991310511	6,21				
	CISTERNA DE PLÁSTICO								
			800 mm.	320611044	3,12				
	TIRADOR W.C.								
			250 mm.	320611034	1,00				
			TORNILLO	320611046	0,35				
	PALANCA W.C.								
			TIRADOR VERTICAL TIPO 5	TV5A	320412042	7,03			
			TIRADOR VERTICAL TIPO 4	TV4A	320412040	6,57			
			RM6x80	320412063	2,18				
	TORNILLOS FIJACIÓN CISTERNA/INODORO								
				320412034	3,47				
	PULSADOR TYFON								



ARCO ESFERA

	MEDIDA	REF.	€	
	10	3/8"Hx3/8"H	100101101	12,15
	25	1/2"Hx1/2"H	100101102	13,05
	20	3/4"Hx3/4"H	100101103	18,84
	10	1"Hx1"H	100101104	28,29
	6	1 1/4"Hx1 1/4"H	100101105	43,31
	4	1 1/2"Hx1 1/2"H	100101106	67,56
	2	2"Hx2"H	100101107	99,10
	2	2 1/2"Hx2 1/2"H	100101108	170,00
	2	3"Hx3"H	100101109	274,55

TAJO 2000

	25	12	100100234	15,99
	25	15	100100238	14,37
	25	18	100100242	14,37
	15	22	100100244	20,22
	10	28	100100246	29,22
	6	35	100100250	52,08

TAJO 2000 SOLDAR

	10	3/8"Hx3/8"H	100101203	11,18
	25	1/2"Hx1/2"H	100101205	9,31
	20	3/4"Hx3/4"H	100101207	13,37
	10	1"Hx1"H	100101209	19,72
	6	1 1/4"Hx1 1/4"H	100101211	34,82
	4	1 1/2"Hx1 1/2"H	100101213	53,60
	2	2"Hx2"H	100101214	77,29
	2	2 1/2"Hx2 1/2"H	100101215	164,85

TURIA 3000

	1/2	401796800	22,56
	3/4	401796801	23,26

CIERRE CERAMICO  
EMPOTRAR KANSAS

	5	1/2"H x 1/2"H	100100337	13,40
	5	3/4"H x 3/4"H	100100338	18,67
	5	1"H x 1"H	100100339	23,65

TEXAS ROSCAR

	5	15	100100345	10,66
	5	18	100100347	13,59
	5	22	100100348	19,16
	5	28	100100349	13,92

TEXAS SOLDAR

	MEDIDA	REF.	€	
	25	1/2"	100152002	5,05
	20	3/4"	100152003	7,52

NILE

H - H			
	1/2"	100151103	4,92
	3/4"	100151104	7,31

NILE

M - H				
	25	1/2"	100152603	5,05
	20	3/4"	100152604	7,50
		1"	100152605	11,21

NILE

	25	1/2"	100151053	5,06
	20	3/4"	100151054	7,55
	10	1"	100151055	11,20
	6	1 1/4"	100151066	17,63
	4	1 1/2"	100151067	26,71
	2	2"	100151068	40,86
		2 1/2"	100151069	75,68
		3"	100150110	165,89

SENA

NILE

	1/2"	991393030	3,77
	3/4"	991393031	5,40
	1"	991393032	8,72
	1 1/4"	991393033	12,50
	1 1/2"	991393034	20,76
	2"	991393035	30,00







	-	100108225	3,64
--	---	-----------	------







PROLONGADOR

	(1)	5	100108201	13,72
	MANDO PALANCA			
	(2)	5	100108202	13,72
	MANDO MASTER			
	(3)	5	100108203	7,15
	MANDO OCULTO			

ARCO JARDIN

ARCO JARDIN				ARCO JARDIN					
MEDIDA	□	REF.	€	MEDIDA	□	REF.	€		
	1/2 - 3/4 - 3/4	30	100100472	17,92		<b>GRIFO CURVO</b>			
<b>DOBLE</b>				1/2" 1/2"	15	100100401	12,49		
				1/2" 3/4"	15	100100413	12,49		
				3/4" 3/4"	10	100100403	17,96		
				1" 1"	6	100100405	26,73		
				<b>GRIFO VINTAGE</b>					
<b>NANO</b>				1/2" 1/2"		100100400	38,29		
	1/2 - 1/2	48	100100460	10,26					
	1/2 - 3/4	48	100100462	10,40					
	1/2" 1/2"		100100473	12,50		1/2"x3/4"	25	100155503	6,45

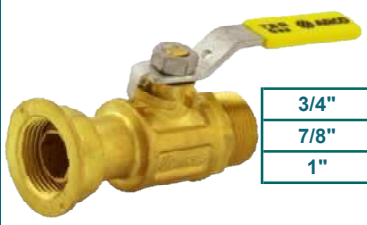
ARCO (GAS)

	<b>J-P-B</b>	<b>LLAVE CON LIMITADOR CAUDAL</b>	1/2"M x1/2"M	360357100	18,52					
	<b>LIMITADOR</b>	10	100500005	15,49		MCC 10	100500905	18,13		
	<b>V-82</b>	1/2"M x1/2"M	45	100500907	11,92	MCC 12	100500911	18,56		
	<b>V-83</b>	3/4"M x 3/4"M	28	100500601	20,29					
	<b>ESCUADRA MARIPOSA</b>	7/8"	15	100500514	23,61		3/4"	20	100500523	14,19
	<b>ESCUADRA PALANCA</b>	7/8"	15	100500513	23,21		7/8"	15	100500510	23,21
							1"	15	100500595	24,16
						<b>T/LOCA PALANCA</b>				
							1/2"	25	100500516	12,67
							3/4"	20	100500501	14,20
							1"	15	100500503	20,40
							1 1/4"	8	100500505	35,27
						<b>M-M PALANCA</b>	1 1/2"	4	100500507	55,33

ARCO

	MEDIDA	REF.	€
<p>A-80</p>	3/8 x 3/8	100100701	9,82
	1/2 x 1/2 ECO	991384001	3,13
	FYCE 1/2 x 3/8 ECO	100100901	3,76
	FYCE 1/2 x 3/8 LARGA	100100903	4,38
	1/2 x 1/2 ANTICAL	100100705	9,20
	1/2 x 3/8 ANTICAL	100100704	8,58
	1/2 x 1/2 ANTICAL (THERMO)	100100706	10,18
	1/2 x 3/8 LARGA ANTICAL	100100088	10,00

	MEDIDA	REF.	€
<p>C-80</p>	PORTAROLLO + LLAVE CORTE		
	1/2 x 3/8	120100080	35,00

	MEDIDA	REF.	€
<p>A-80-C</p>	3/8"H x 3/8"	100100715	10,70
	1/2"H x 3/8"	100100716	8,43

	MEDIDA	REF.	€
<p>TWIN</p>	1/2 x 3/8 x 3/8	100100720	24,42

	MEDIDA	REF.	€
<p>COMBI</p>	COMBI	100100732	23,33
	3/8 x 1/2	100100288	1,98
	3/8 x 3/4	100100289	2,44

ADAPTADORES

	MEDIDA	REF.	€
<p>ARCO KIT THERMO XFLOW (LLAVE+CODO)</p>	1/2x1/2	100100290	14,87

	MEDIDA	REF.	€	
<p>COMPUERTA CIERRE GOMA</p>	1/2"	21	100101861	7,76
	3/4"	18	100101862	10,11
	1"	12	100101863	17,58
	1 1/4"	6	100101864	27,10
	1 1/2"	3	100101865	38,47
	2"	2	100101866	52,98
	2 1/2"	3	100101867	107,56
	3"	2	100101868	154,68

	MEDIDA	REF.	€	
<p>L-85 LAVADORA</p>	1/2x3/4	60	100100728	8,38
	1/2x3/4		100100904	4,62

	MEDIDA	REF.	€
L-86 LAVADORA		100100729	10,20

	MEDIDA	REF.	€	
<p>VALVULA DE RETENCION</p>	1/2"H x 1/2"H	45	100101701	6,30
	3/4"H x 3/4"H	24	100101702	8,32
	1"H x 1"H	18	100101703	11,03
	1 1/4"H x 1 1/4"H	12	100101704	15,93
	1 1/2"H x 1 1/2"H	6	100101705	22,04
	2"H x 2"H	3	100101706	30,47
	2 1/2"H x 2 1/2"H	2	100101707	77,20

	MEDIDA	REF.	€
<p>VALVULA DERETENCION</p>	3/4"M x 3/4"M	500658010	7,04

	MEDIDA	REF.	€
<p>MINI MACHO-HEMBRA</p>	1/2"M x 1/2"H	100102204	9,06

	MEDIDA	REF.	€	
<p>FILTRO INCLINADO</p>	1/2"	36	100101830	5,64
	3/4"	24	100101831	9,12
	1"	18	100101832	12,87
	1 1/4"	7	100101833	26,34
	1 1/2"	4	100101834	32,69
	2"	2	100101835	48,24

	MEDIDA	REF.	€
<p>SEGURIDAD TERMO</p>	1/2	100100291	7,00



























**gebo**<sup>®</sup>  
[www.gebo.es](http://www.gebo.es)

*Especialistas  
en Uniones*



## JIMTEN

	MEDIDA	REF.	€		MEDIDA	REF.	€
 <p>S-11</p>	1 1/4 x 63	461011114	11,68	 <p>S-7</p>	1 1/2	461007112	17,80
	1 1/2 x 63	461011112	12,01		 <p>S-10</p>	1 1/2 x 85	461010112
 <p>S-61</p>	1 1/4 x 63	461061114	12,99	 <p>S-30</p>		1 1/2"	461030112
	1 1/2 x 63	461061112	13,46		 <p>S-501 LAVABO / BIDET</p>	1 1/4 x 63	461050114
 <p>S-69</p>	1 1/4"	461069114	7,03	 <p>CLICK-CLACK FLAT LAVABO / BIDET S-600 ( C )</p>		1 1/2 x 63	461050113
	1 1/2"	461069112	7,31		 <p>S-601 ( N )</p>	1 1/4 x 63	461054010
 <p>S-84</p>	1 1/4 x 63	461084114	12,76	 <p>CROMO</p>		1 1/2 x 63	461054011
	1 1/2 x 63	461084112	13,46		 <p>VALVULA CLIC-CLAC</p>	991393080	21,58
 <p>S-151</p>	1 1/4"	461015114	6,10	 <p>NEGRO</p>		460000413	25,07
	1 1/2"	461015112	6,56		 <p>S-51</p>	1 1/2 x 70	461051112
 <p>S-29</p>	1 1/4"	461029114	7,39	 <p>S-158</p>		1 1/2 x 85	461017412
	1 1/2"	461029112	7,62		 <p>S-174</p>	1 1/2 x 70	461015812
 <p>S-39</p>	1 1/4"	461039114	7,39	 <p>(1) S-337</p>		(1)	461033700
	1 1/2"	461039112	7,62		 <p>(2) S-237</p>	(2)	461023700
 <p>S-380</p>	1 1/2"	461038000	32,36	 <p>S-236</p>		1 1/2 x 115	461023600
	SOLFLESS	991360285	10,32		Rebosadero rectangular		
 <p>KELSO (Valv. Autom.)</p>	1 1/2 x 40	991302010	27,87	 <p>S-34</p>	1 1/2 x 40	461034112	21,64

# FONTANERÍA

## JIMTEN

MEDIDA			REF.	€	MEDIDA			REF.	€
 <p>S-578</p>	1 1/2 x 90	461013578	38,18		40/50	460415050	10,44		
	1 1/2 x 85	461013678	28,66		40/50	461132278	13,83		
					50/40	460419250	8,89		
 <p>S-134</p>	1 1/2 x 80	461013480	7,79	50/40	460419150	8,89			
	1 1/2 x 115	461013415	10,32						
 <p><b>SOLFLESS</b></p>	90/110	991310903	18,24	<p>SUMIDEROS</p>					
				75	460424775	23,12			
				90	460424790	37,16			
				110	460424711	37,13			
				<p>CALDERETAS</p>					
				110	460424811	41,08			
				<p>S-258</p>					
				110	460424820	37,35			
									
 <p>CICLÓN 3</p>	461117551		899,96	 <p>ESTACIÓN DE BOMBEO</p>			461117541		714,05
	5M ↑			7M ↑					
<p><b>SOLFLESS</b></p>									
 <p>DURBAN</p>	32x1"1/4	991360258	15,84	 <p>T. FRANCIA</p>			<p><b>SOLFLESS</b></p> <p>TIERRA FRANCIA</p>		
				 <p>BLANCO</p>			<p>991305041</p>		9,40
 <p>KROM</p>	32x1"1/4	991360257	14,94	<p>VÁLVULA CESTA</p>			<p>991305042</p>		9,37
				<p>BLANCO</p>					
 <p>LOIRA</p>	32x1"1/4	991360259	19,07	<p><b>SOLFLESS</b></p>			<p>TIERRA FRANCIA</p>		
				 <p>BLANCO</p>			<p>991305061</p>		11,41
				<p>T. FRANCIA</p>			<p>BLANCO</p>		
				<p>VÁLVULA CESTA CON REBOSADERO</p>			<p>991305062</p>		11,38

## JIMTEN

		MEDIDA	REF.	€			MEDIDA	REF.	€		
	S-182 CROMO	1 1/4"	460618214	30,99		S-183 CROMO	1 1/4 x 1 1/2 - 40/50	991360248	3,25		
		1 1/2"	460618212	32,46			A-104	1 1/4 x 32/40	461010432	7,74	
								1 1/2 x 40/50	461010140	8,64	
	S-205 CROMO	1" 1/4	460618314	32,09		PANTHER	1 1/4 x 32/40	991360246	4,46		
		1" 1/2	460618312	32,49			1 1/2 x 32/40	991360247	4,48		
		11/4"x70	460620524	47,95			S-16	8-15	461316008	0,48	
11/2"x70	460620522	47,95	12-25	461316015	0,48						
			32-35	461316032	0,48						
	A-35 CROMO	32-1 1/4"	460635114	13,78		S-130	40-1 1/2"	460635112	3,00		
		40-1 1/2"	460635112	3,00			90	460213090	11,90		
							110	460213011	12,71		
	A-68 CROMO	40-1 1/2"	460000414	9,36		A-15	1 1/4"	461315114	2,54		
							1 1/2"	461315112	2,76		
							1 1/4"	461314114	4,23		
	IBIDE	40	460000402	3,04		A-14	1 1/2"	461314112	4,90		
		40	460000406	3,07				TAPÓN A-126	1/2" Azul	461012613	1,32
									1/2" Rojo	461012612	1,32
	A-137 CROMO	32	460668114	8,60		A-311	1 1/2"	461340112	2,72		
		40	460668112	9,03			A-1	A-1	1 1/2"	461301112	9,03
	IBIDE	32	460000402	3,04		A-72 CROMO	1" 1/4	460672114	7,84		
		40	460000406	3,07			1" 1/2	460672112	8,31		
							1" 1/2	460000415	3,92		
	A-7	32-1 1/4"	461311432	0,60		A-319	1 1/4"	461302114	4,27		
		40-1 1/2"	461311240	0,60			1 1/2"	461302112	2,50		
		32-1 1/2"	461311232	0,60			A-2	A-2	461322112	2,48	
	A-137 CROMO	32	460613714	9,45		A-2	1" 1/4 x 32	461303114	2,49		
		40	460613712	8,35			1" 1/4 x 40	461304114	2,76		
							1" 1/2 x 40	461303112	4,17		
	IBIDE	40	460000416	4,29		A-3	40mm (Jimten)	461304940	4,90		
							40mm (Adequa)	461100544	1,57		
							32mm (Adequa)	461100543	1,28		
	A-72 CROMO	1" 1/4	460672114	7,84		A-49					
		1" 1/2	460672112	8,31							
		1" 1/2	460000415	3,92							
	A-7	1" 1/4	461307114	2,93							
		1" 1/2	461307112	2,93							
	A-131 CROMO	32-40 x 1" 1/4	460613114	24,53							
		40-50 x 1" 1/2	460613112	25,60							
	ALARGADERA CROMO 40 x 50mm		460000530	7,55							
	ALARGADERA SIFÓN LATÓN CROMADO		460000044	6,88							



EL ÚNICO SISTEMA  
PP-R y PE-100  
FABRICADO EN ESPAÑA

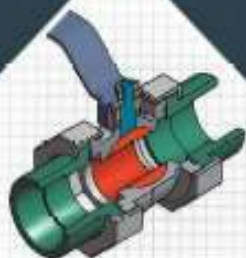

# REPOLEN<sup>®</sup>



PPR SYSTEM



PE-100 SYSTEM



PE-RT II SYSTEM



HERRAMIENTAS Y ACCESORIOS



BATERÍAS Y COLECTORES



TUBOS P.E. Y ACCESORIOS



ACCESORIOS COMPRESIÓN



Zona Norte: José Requena  
joseventas@reboca.com  
+34 654 192 867

Zona centro: Sergio Ortega  
sergiowintas@reboca.com  
+34 671 342 061

Zona Sur: Francisco Ubeda  
fuaventas@reboca.com  
+34 656 094 610



## BATERIAS DE CONTADOR

MEDIDA			REF.	€	MEDIDA			REF.	€	
	2 1/2" - 2" 3/4" 6	601062346	279,66		2 1/2" - 2" 3/4" 4	601082344	228,63		601088134	21,22
	2 1/2" - 2" 3/4" 8	601062348	293,39		2 1/2" - 2" 3/4" 6	601082346	306,61			
	2 1/2" - 2" 3/4" 10	601073410	337,00		2 1/2" - 2" 3/4" 8	601082348	350,22			
	2 1/2" - 2" 3/4" 12	601073412	358,15		2 1/2" - 2" 3/4" 10	601082350	391,19			
	2 1/2" 3/4" 14	601073414	396,48		2 1/2" - 2" 3/4" 12	6123412	326,00			
	2 1/2" 3/4" 16	601073416	437,44		2 1/2" 3/4" 14	612123414	355,00			
	2 1/2" 3/4" 18	601073418	471,81		Juego Llaves 3/4	601099999	17,32			
	2 1/2" 3/4" 20	601073420	500,88							
	2 1/2" 3/4" 22	601073422	543,17							
	2 1/2" 3/4" 24	601073424	557,71							
	2 1/2" 3/4" 26	601073426	596,04							
2 1/2" 3/4" 28	601073428	634,36								
Juego Llaves 3/4	601099999	17,32								
			102035222	19,40						

CENTRAL

\*Precios sin llaves

REVERSIBLE

\* Precios sin llaves

VALVULA  
ESFERA  
BRIDA 3/4

VALVULA C/RETENCION 3/4  
BOSTON



BATERIA ACERO GALVANIZADO  
2 FILAS

Nº CONTADORES	FILAS	PULGADAS	REF.	EUROS
12	2	2 1/2"	20122S	348,56
14	2	2 1/2"	20142S	375,55
16	2	2 1/2"	20162S	402,29
18	2	2 1/2"	20182S	432,67
20	2	2 1/2"	20202S	455,17
22	2	2 1/2"	20222S	480,63
24	2	2 1/2"	20242S	506,92



BATERIA ACERO GALVANIZADO  
2 FILAS

Nº CONTADORES	FILAS	PULGADAS	REF.	EUROS
12	3	2 1/2"	30123S	403,57
15	3	2 1/2"	30153S	445,59
18	3	2 1/2"	30183S	486,99
21	3	2 1/2"	30213S	528,12
24	3	2 1/2"	30243S	568,13



100101300 36,78

VÁLVULA ESFERA  
ENTRADA  
21,8 IZQUIERDA



100102100 2,54

SIL TUERCA 3/4 H  
SAL.IZQ.



100101301 26,70









VÁLVULA ESFERA  
SALIDA  
21,8 IZQUIERDA x 3/4

## BATERIAS DE CONTADOR

	MEDIDA	REF.	€
<b>DEPÓSITO HIDRONEUMÁSTICO GRUPOS DE PRESIÓN</b>			
	Sin patas (10 bar-1")		
	24 lts.	141805061	49,73
	Con patas (10 bar-1")		
	50 lts.	141804021	120,32
	80 lts.	141804025	151,69
	100 lts.	141804063	220,96
	Con patas (10 bar-1" 1/4)		
	150 lts.	141804022	348,44
	200 lts.	141804023	390,64
	300 lts.	141804024	469,52
<b>CALDERIN SIN MANTENIMIENTO</b>			
	24 lts.	141855024	88,00
	60 lts.	141855060	266,70
	100 lts.	141855061	431,00
	150 lts.	141855062	611,35
	<b>CHORRO ÚNICO AGUA FRIA 3/4</b>		
		991393089	42,09
<b>CHORRO MULTIPLE 1" (DN20)</b>			
		6029 06	86,78
<b>DIDO PLATA *Cumple CTE</b>			
	1" 1/4	600420146	470,00
	1" 1/2	600420148	590,00
	2"	600420147	640,00

	MEDIDA	REF.	€
<b>REDUCTOR DE PRESIÓN</b>			
	1/2	991375020	27,40
	3/4	991375022	30,56
	1	991375023	49,97
	1 1/4	991375007	78,40
	1 1/2	991375008	97,66
	2	991375009	113,10
<b>Honeywell</b>			
	1/2	180620004	123,80
	3/4	180620005	128,70
	1	180620006	169,00
<b>D06</b>			
	Manometro glicerina 63 (0-10) 1/4		140263006 14,22
	Termómetro dorsal 0-120 con vaina		140263008 9,86
	Termómetro contacto 63 con muelle		140263024 10,94
	Manómetro toma posterior		140263002 6,86
	Manómetro seco		140263004 6,61

## BOMBAS

REF.			€	REF.			€
<b>Viviendas tipo D</b>	<b>Alturas edificio</b>	<b>Caudal max. M3/h</b>		<b>Altura (m.c.a)</b>	<b>Modelo</b>		
De 1 a 10	Hasta 12	2,4 - 9,6		80-27	AP-HI MASTER A/15-2	4.497,00	
De 11 a 20	Hasta 8	2,4 - 9,6		80-27	AP-HI MASTER A/15-2	4.497,00	
De 21 a 30	Hasta 14	4,8 - 14,4		96-41	AP-HI MASTER B/25-2	4.695,00	
De 31 a 50	Hasta 6	4,8 - 14,4		96-41	AP-HI MASTER B/25-2	4.695,00	
				1 bomba <i>sin alternancia</i> AP HI B-15		1.801,88	
				1 bomba <i>sin alternancia</i> AP HI B-20		1.932,42	
							
							
	0,75 CV	140291037	467,00	PRESSCOMFORT 1,5 BAR		141203254	70,71
GP-AGA							
				CONTROL PRESS 1,5 / 3 BAR		141203253	70,71
							
PRESOSTATO ELECT. SWITCH MATIC 2						5 MTS	
						141050004	29,00
							
	0,8 CV	140251057	413,00	BOYA AGUAS FECALES		10 MTS	
	1 CV	140251067	530,00			140262201	108,00
	1,2 CV	140251097	643,00				
GP-COMPACT							

## BOMBAS

AGUAS SUCIAS			AGUAS LIMPIAS		
	REF.	€		REF.	€
 <p><b>RIGHTH 75MA</b></p> <p>*0,75 CV *Paso solidos 35mm</p>	140217531	609,00	 <p><b>OPTIMA MA</b></p> <p>*0,33 CV Paso sólidos 10mm</p>	140217511	358,00
 <p><b>DAR</b></p> <p>*1,5 CV *Paso solidos 50mm</p>	140261012	923,00	 <p><b>OPTIMA MS</b></p> <p>*0,33 CV Paso sólidos 10mm</p>	140217521	388,00
 <p><b>VERSATYLE (SG1000)</b></p>	140261011	516,00	 <p><b>BESTONE VOX (VORTEX)</b></p> <p>*0,33 CV Paso sólidos 20mm</p>	140217411	446,00
 <p>13.000 L/H</p>	420402293	77,45	 <p><b>LAGO</b></p> <p>300</p>	140292011	206,00
 <p>15.500 L/H</p>	420402295	112,45	 <p>500</p> <p>6.000 L/H</p>	140292021	231,00
				420402288	59,45



**E.SYBOX MINI**

140463600	1.073,00
-----------	----------



**RACORES 1"**



140400630	46,00
-----------	-------





**E.SYBOX**

140447200	1.796,00
-----------	----------

**BOMBAS (AGUAS LIMPIAS)**

	REF.	€		REF.	€
 <p>*0,55 CV</p>	QDP-400A		 <p>*0,9 CV</p>	HMC90-3SH	
	140102001	76,17		140101001	170,79

**BOMBAS (AGUAS SUCIAS)**

	REF.	€		REF.	€																				
	H800F-B			HWD-750S																					
	140103002	172,76		140103003	251,34																				
	QDS-750CW		<table border="1"> <thead> <tr> <th>MODELO</th> <th>H800F-B</th> <th>QDS-750CW</th> <th>HWD-750S</th> </tr> </thead> <tbody> <tr> <td>POT. (Cv)</td> <td>1,1 Cv</td> <td>1 Cv</td> <td>1 Cv</td> </tr> <tr> <td>H MAXIMO (m)</td> <td>10 m</td> <td>9 m</td> <td>12 m</td> </tr> <tr> <td>Q MAXIMO (m<sup>3</sup>/h)</td> <td>18 m<sup>3</sup>/h</td> <td>9,6 m<sup>3</sup>/h</td> <td>15 m<sup>3</sup>/h</td> </tr> <tr> <td>CONEXIÓN</td> <td>2"</td> <td>1 1/2"</td> <td>1 1/2"</td> </tr> </tbody> </table>			MODELO	H800F-B	QDS-750CW	HWD-750S	POT. (Cv)	1,1 Cv	1 Cv	1 Cv	H MAXIMO (m)	10 m	9 m	12 m	Q MAXIMO (m <sup>3</sup> /h)	18 m <sup>3</sup> /h	9,6 m <sup>3</sup> /h	15 m <sup>3</sup> /h	CONEXIÓN	2"	1 1/2"	1 1/2"
	MODELO	H800F-B	QDS-750CW	HWD-750S																					
POT. (Cv)	1,1 Cv	1 Cv	1 Cv																						
H MAXIMO (m)	10 m	9 m	12 m																						
Q MAXIMO (m <sup>3</sup> /h)	18 m <sup>3</sup> /h	9,6 m <sup>3</sup> /h	15 m <sup>3</sup> /h																						
CONEXIÓN	2"	1 1/2"	1 1/2"																						
140103001	123,97																								

**BOMBAS (CONTROL)**

	REF.	€		REF.	€
	EPC-1			EPC-3	
	140104001	38,52		140104002	37,21

## HERRAMIENTAS

MEDIDA REF. €			MEDIDA REF. €		
	420400722	17,45		7"	420407522 18,95
COTATUBOS MINI 722				10"	420400522 23,45
	420400725	20,45		12"	420412522 31,05
CORTATUBOS 725				L=10"	420401399 56,95
	CU 35 420400735 48,95			L=14"	420401400 61,45
	INOX 42 420400238 56,45			L=18"	420401301 84,45
CORTATUBOS TELESCOPICO 735				L=24"	420401302 148,95
	420400750 129,95			1/2"	420400500 46,45
	PE 6-67mm 420470031 134,95			1"	420401000 54,45
	PE 50-125mm 420470032 232,45			1 1/2"	420401501 75,45
CORTATUBOS AUTOMATICO 750				2"	420402000 116,45
	420461004	299,95			420403506 20,95
BOMBA DE COMPROBACION RP 50 S					420403508 16,95
	420400902	14,45			420403510 18,45
GRIFOS PARA BOTELLA AZUL					420403512 29,95
					420403515 49,45
					420400170 14,95
					420401202 2,55
					420401203 1,15
					420485112 815,95
					BOMBA DESINCRUSTANTE ROCAL 20
					10 Kg. (cu) 420400851 67,95
					5 Kg. (cu) 420400850 38,45
					420400852 23,45
					LIQUIDOS DESINCRUSTANTES
					NEUTRALIZANTE

## HERRAMIENTAS

MEDIDA			REF.	€	MEDIDA			REF.	€
	7,5 m	ROSPI	420419950	164,95		2 m.	420400002	17,45	
	MUELLE					5 m.	420400005	25,45	
	8mm x 7,5 mts.		420472412	96,45					
	10 mts	ROSPI	420417205	255,45					
	MUELLE								
	10mm x 10 mts.		420402422	123,95					
	Conex. EU								
			420405501	115,45					
	PACK 10 DISCOS		420485510	21,95					
	115.1,5 (1 UD.)		420610015	2,28					
DISCO METAL 1,5									
	26 TC		420405090	38,95					
	32 TC		420405085	54,95					
	Cuchilla		420452041	28,45					
	42 TC		420405091	70,95					
	Cuchilla		420405092	41,45					
	50 TC		420405093	100,95					
	63 TC		420405094	146,95					
	75 TC		420405095	244,95					
				BOMBA DE VACÍO R32					
						420401510	214,45		
				MULTIGAS 300					
				(1)	420400510		7,15		
				RO MAPP					
				(2)	420400511		18,45		
				ABOCINADOR R32					
						420401408	59,45		
				MANÓMETRO R32					
						420401511	48,95		
				MANGUERAS R32					
						420401406	39,95		
				LLAVES ALLEN EN SOPORTE METALICO					
						420401215	8,25		
				2,5 - 10 mm.					
						420403284	68,95		
				3/8" - 3/4"					
				LLAVE DE RADIADORES					
						420403105	40,95		
				ALFOMBRA IGNÍFUGA					



HERRAMIENTAS

REF.	€	REF.	€
 SOPLETE KT777P 423010121 91,78	(3)  (4)  (3) BOTELLA DE GAS KSUPRAGAS330 423010102 4,40  (4) BOTELLA DE GAS MAP-PLUS 423010101 7,70		
 SOPLETE KT637 423010127 61,62	 42mm 423010123 29,57 50mm 423010113 42,03 TIJERA		
 SOPLETE KT637 423010103 40,40	 CORTATUBOS 6-35 423010162 12,92		
 SOPLETEKT937 423010128 32,04	 TIJERA 35MM 423010122 8,10		
 SOPLETE KT957RTN 423010129 37,70	 BOMBA DE COMPROBACIÓN MANUAL KHTP-50 423010107 183,95		

## HERRAMIENTAS

		REF.	€	MEDIDA	REF.	€	
<p><b>SPORT</b>      TALLAS 40-46</p>	40	423010142	31,85	<p><b>LLAVE DE CADENA REVERSIBLE 4"</b></p>	423010124	28,54	
	41	423010143	31,85				
	42	423010144	31,85				
	43	423010145	31,85				
	44	423010150	31,85				
	45	423010151	31,85				
	46	423010146	31,85				
<p><b>RACING</b>      TALLAS 40-46</p>	40	423010152	31,01	<p><b>LLAVE DE CORRE 12"</b></p>	423010125	28,55	
	41	423010153	31,01				
	42	423010154	31,01				
	43	423010155	31,01				
	44	423010147	31,01				
	45	423010148	31,01				
	46	423010149	31,01				
<p><b>SQUASH</b>      TALLAS 41-46</p>	41	423010156	34,37	<p><b>TIJERA CHAPA PLADUR</b></p>	423010140	16,04	
	42	423010157	34,37				
	43	423010158	34,37				
	44	423010159	34,37				
	45	423010160	34,37				
	46	423010161	34,37				
	<p><b>RODILLERAS GEL</b></p>	423010139	21,24				<p><b>SERRUCHO PLADUR</b></p>
<p><b>POLIFUSOR KPHPW800W Ø 20-63</b></p>	423010137	13,41	<p><b>MUELLE DESATASCADOR ALUMINIO</b></p>	8mm x 5mts	423010137	13,41	
	423010105	93,10		6mm x 3mts	423010108	7,30	
	<p><b>POLIFUSOR KPHPW1200W Ø 75-90-110</b></p>	423010134		35,19	14"	423010134	35,19
		423010106		106,42	18"	423010135	44,01
24"			423010136		52,77		
<p><b>GUANTE FLEX PRO KAP442 1,2mm</b></p>	423010109	10,42	<p><b>TENAZA CANAL 10"</b></p>	423010109	10,42		
<p><b>GUANTE FLEX KAP440 1mm</b></p>	423010131	15,34	<p><b>GRAN APERTURA</b></p>	6"	423010131	15,34	
	423010132	17,64		8"	423010132	17,64	
<p><b>GUANTE FLEX PRO KAP442 1,2mm</b></p>	T-7	423046360	3,19	<p><b>GUANTE FLEX KAP440 1mm</b></p>	T-7	423046364	2,19
	T-8	423046361	3,19		T-8	423046365	2,19
	T-9	423046362	3,19		T-9	423046366	2,19
	T-10	423046363	3,19		T-10	423046367	2,19

# RP 115 HERRAMIENTA DE PRENSAR

**RIDGID**

**¡NOVEDAD!**

RIDGID PRESENTA LA NUEVA **RP 115**

**MICRO** | **RENDIMIENTO**  
**PRENSADO** | **SOBRESALIENTE**



MICRO para facilitar el uso en pequeños espacios



La más ligera del mundo, con un peso de tan solo 1,38 Kg\*



Gran Potencia y fiabilidad para pequeños diámetros:  
Cu / ST - max. 28 mm  
Pex / MPL - max. 32 mm



Ciclo de prensado en 3 Seg.



Cabezal de rotación de 350°  
Prensa en cualquier sitio y en cualquier posición.



Diseño ergonómico SlimGrip™  
Perfecto manejo y control



Mordazas MICRO de 15Kn  
para mejor acceso de prensado



DOS baterías, con comprobador de carga incluido.

## HERRAMIENTAS

MEDIDA	REF.	€	MEDIDA	REF.	€	
	423057043	94,72	<b>MAQUINA PRENSAR RP115 (16-32) INCLUYE 2 BATERIAS</b>			
<b>MUELLE</b>	423042163	46,73		<b>PACK 16-20-25</b>	423073898	1.199,00
<b>DESATASCADORA POWER SPIN+</b>				<b>INOX M15</b>	423069357	134,50
				<b>INOX M18</b>	423069359	134,50
				<b>INOX M22</b>	423069360	134,50
	423076188	495,65	<b>INOX M28</b>	423069361	134,50	
<b>EQUIPO DE LIMPIEZA DE TUBERIAS K9</b>			<b>INSERCION RFz 32</b>	423069358	88,18	
	423059143	341,40	<b>DESATASCADORA K-45 Hasta 75mm</b>			
<b>DESATASCADORA POWERCLEAR™</b>				423036043	582,00	
<b>CABLE REPUESTO</b>	423055983	66,10	<b>MUELLE</b>	423056782	145,70	

## BROCAS



MEDIDA MM	CODIGO	REF.	€	MEDIDA MM	CODIGO	REF.	€	
<b>TWISTER PLUS SDS</b>	6 x 110	423076110	110D06L0110	3,49	<b>MULTIMATERIAL</b>	6	215D06	5,07
	6 x 160	423076160	110D06L0160	3,49		8	215D08	5,59
	8 x 160	423078160	110D08L0160	3,88		10	215D10	6,28
	10 x 160	423070160	110D10L0160	5,00		12	215D12	7,76
<b>OPTIMA 3+ HORMIGÓN</b>	5	423072635	263D05	2,62	<b>BLUE CREAM</b>	6	423042606	23,72
	6	423072636	263D06	2,69		8	423042608	25,55
	8	423072638	263D08	3,18	<b>ADAPTADOR PARA AMOLADORA</b>	Ø 1'5 - 13	423001240	62,55
	10	423072630	263D10	4,45				
<b>BROCA VIDRIO</b>	4	423074004	400D04	5,29	<b>4G4 SDS</b>	6 x 160	423071121	4,95
	5	423074005	400D05	5,73		6 x 210	423071122	5,31
	6	423074006	400D06	6,13		8 x 160	423071123	5,73
	8	423074008	400D08	6,98		8 x 210	423071124	6,11
						10 x 160	423071125	6,27
						10 x 210	423071126	6,98
						12 x 160	423071127	6,78

OSMOSIS FLUJO DIRECTO / COMPACTA

REF.

€



**ECO4000**

OSMOSIS INVERSA FLUJO DIRECTO

MEMBRANA Y FLITRO 5 EN 1

316x158x408 mm

REF.	€/Neto
600300011	330,00
600300012	75,00



## Waterfilter

**ODIRECT 800**

OSMOSIS ODIRECT FLUJO DIRECTO

385x465x160mm

CARTUCHO RECAMBIO MEMBRANA 800GPD

600801610	1.080,00
600801601	32,31
600801602	180,00



**GENIUS**

ÓSMOSIS COMPACTA 5 ETAPAS GENIUS

430x240x420 mm

SIN BOMBA  
CON BOMBA

600234073	472,00
600234074	652,00

KIT FILTROS GENIUS

600234089	46,00
-----------	-------



## Waterfilter

**ÚNICA**

495x370x210mm

600804495	287,00
-----------	--------



## Waterfilter

**ULTRAFILTRACIÓN**



DIRECT	600880156	142,00
--------	-----------	--------

1 VIA	600880158	183,00
-------	-----------	--------

## COMPLEMENTOS

	REF.	€		REF.	€	
			<b>GRIFO ÓSMOSIS MARGARITA</b>			
	600412230	32,96		<b>KIT FILTRACION</b>		
				600879560	42,00	
	(1)		(1) KIT 3 FILTROS	600412085	4,51	
	(2)		(2) KIT 4 FILTROS	<b>HILO BOBINADO</b>		
	(3)		(3) KIT 5 FILTROS			
	600887633	17,44		<b>ANALIZADOR TDS</b>		
	600887638	24,01		600867900	31,35	
	600887632	60,00		<b>ANALIZADOR DUREZA</b>		
	600891803	11,50		600871800	26,25	
<b>SEDIMENTOS (CS)</b>						
	600891902	12,90				
<b>CARBÓN (CS)</b>						
	600891919	10,00				
<b>STELLA Y CS COMPACTA POSTFILTRO</b>						
	600804114	52,00				
<b>MEMBRANA ÓSMOSIS</b>						
	600804115	66,00				
<b>MEMBRANA ÓSMOSIS BAJO RECHAZO (1/1)</b>						
	600412090	7,21				
<b>POSTFILTRO UNIVERSAL</b>						
				1/4	600412110	1,65
				3/8	600412120	2,78
				1/4	600412100	5,00
				1/4 x 1/4	600809234	2,25
				1/4 x 3/8	600809236	2,50
				1/4 x 1/4	600809214	2,50
				3/8 x 3/8	600809216	2,50
				1/4 x 3/8M	600809246	3,15
				3/8 x 3/8M	600809256	2,50
				1/4	600809224	2,25
				1/4 x 1/4M	600809204	2,15
				1/4	600412130	0,21
				3/8	600412140	0,25

## DESCALCIFICACIÓN Y FILTROS

1100x360x530 RIDER	1034x333x565 DENVER 30 L	1170x360x55 WATERMARK 30 L	1086x438x524 ROBOSOFT	1055x333x333 QUANTUM SOFT
600865238 1050,00 €	600862917 1198,00 €	600879521 1338,00 €	600231526 1911,00 €	600300013 410,00 € €/Neto
CONEXIÓN 1"	CONEXIÓN 1"	CONEXIÓN 3/4"	CONEXIÓN 1"	CONEXIÓN 3/4"

ESSENTIAL		REF.	€	
	508x293x500 8 LTS.	600801708	1.156,00	
	608x297x500 11 LTS.	600801711	1.297,00	
	780x303x503 17 LTS.	600801717	1.350,00	
	SAL DESCALCIFICADOR	600400037	12,31	
	SAL KINETICO	600820701	16,12	
	(1) FILTERMAX 3/4	600890161	99,00	
	(2) HONEYWELL	3/4	180603941	88,70
		1"	180603940	108,04
	(3) FILTERMAX B	1"	600873626	282,79
		1"1/4	600873627	307,59
		1"1/2	723628	975,88
2"		723629	996,64	

## FOSAS CON PREFILTRO BIOLÓGICO

REF.

€



**ROTHERPUR BIO**  
Fosa Séptica  
con prefiltro biológico

**TABLAS**  
**PAG. 74**



**FOSA SEPTICA**      2000 L.

<b>FSH2000</b>	<b>998,33</b>
----------------	---------------

## OXIDACION TOTAL



**MICROSTEP COMPACT (2-5 HE)**

<b>1220300469</b>	<b>3.620,00</b>
-------------------	-----------------



**EP480 (4 HE)**  
**EP900 (7 HE)**

<b>33005013</b>	<b>3.247,92</b>
<b>33005009</b>	<b>5.567,85</b>



**PS4 STIM (5 HE)**

<b>33005070</b>	<b>4.373,10</b>
-----------------	-----------------

## SEPARADOR DE GRASAS



**VOLUMEN ÚTIL 48 L.**

<b>IS00510</b>	<b>145,23</b>
----------------	---------------



**ROTHAGUA**

TABLAS  
PAG. 74



	<b>CONTRABRIDAS</b>	
1"	260900101	35,90
1 1/2"	260900103	35,90
1 1/4"	260900102	35,90
2"	260900104	35,90

**ROTHAGUA (CONTRAINCENDIOS)**

TABLAS  
PAG. 74



	Its	REF.	€
	300	260670300	188,00
	500	260670500	218,00
	1000	260671000	331,00

FIBRA CILÍNDRICO

**ROTH DUO SYSTEM**

TABLAS  
PAG. 74

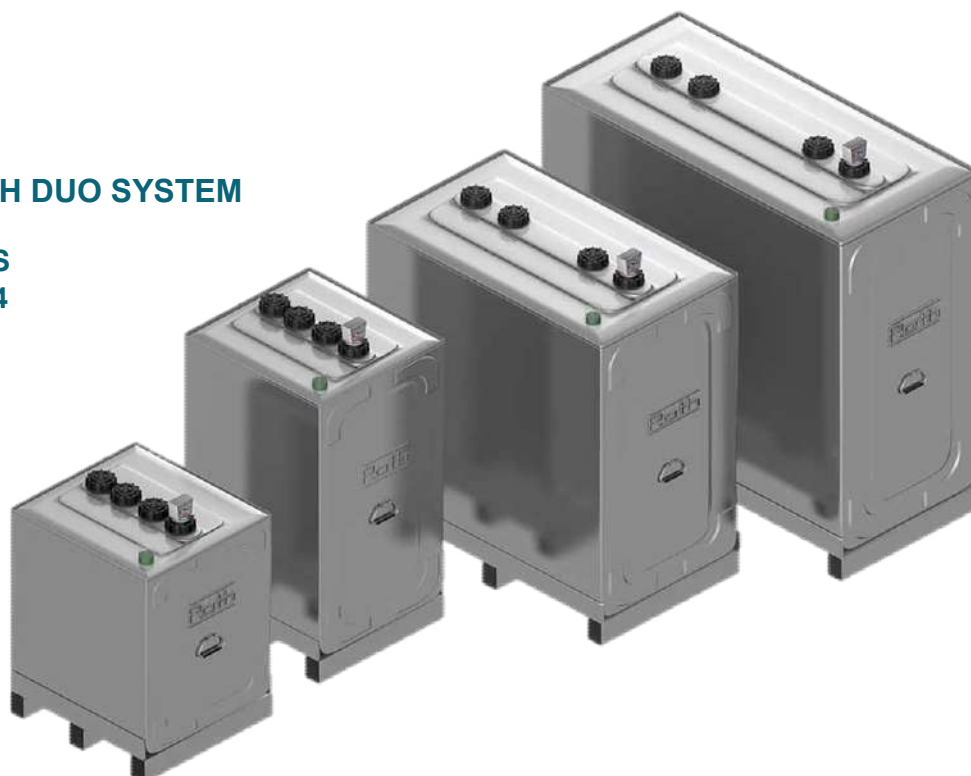

## ROTHAGUA

Modelo	Longitud (mm)	Anchura (mm)	Altura Total	Volumen (l)	Referencia	PVP €/ud
RB-500	1.060	660	1.004	500	1520500040	337,00
RB-700	1.060	660	1.395	700	1520700041	403,50
RC-750	730	730	1.640	750	2561013204	403,50
RC-1000	1.360	720	1.330	1.000	1561017210	458,00
RDB-1100	1.060	660	1.900	1.100	260900002	502,00
RDB-2000	2.250	720	1.695	2.000	1522000070	945,00
RDBA-3000	2.250	990	1.695	3.000	260900003	1.242,00
RB-3000	2.630	880	1.650	3.000	1561017230	1.685,00

## ROTHAGUA (CONTRAINCENDIOS)

Modelo	Longitud (mm)	Anchura (mm)	Altura Total	Volumen (l)	Referencia	PVP €/ud
Bateria contra	2.650	4.300	1.695	12.000	1580100236	4.998,00

## ROTHERPUR BIO (Fosa Séptica con prefiltro biológico)

Modelo	Longitud (mm)	Anchura (mm)	Altura Total (mm)	Ent/Sal. (mm)	Volumen (l)	h.e.	Referencia	PVP €/ud
FR-BIO-1000	1.235	720	1.300	110	700	4	260800001	665,00
FR-BIO-1500	1.880	720	1.480	110	700	6	260800002	883,00
FR-BIO-2000	2.020	880	1.650	110	1.000	8	260800003	1.090,00

## ROTH DUO SYSTEM (GASOIL)

Modelo	Longitud (mm)		Anchura (mm)	Altura Total (mm)	Capacidad (litros)	Referencia	PVP €/ud
	con asas	sin asas					
Roth DUO SYSTEM 400	755	730	700	400	400	1820400001	865,00
Roth DUO SYSTEM 620	750	730	700	620	620	260750001	985,00
Roth DUO SYSTEM 1000	1.290	1.260	760	1.000	1.000	1821000004	1.235,00



**Aerotermia Alta Tª**



**Soportes Antivibratorios**

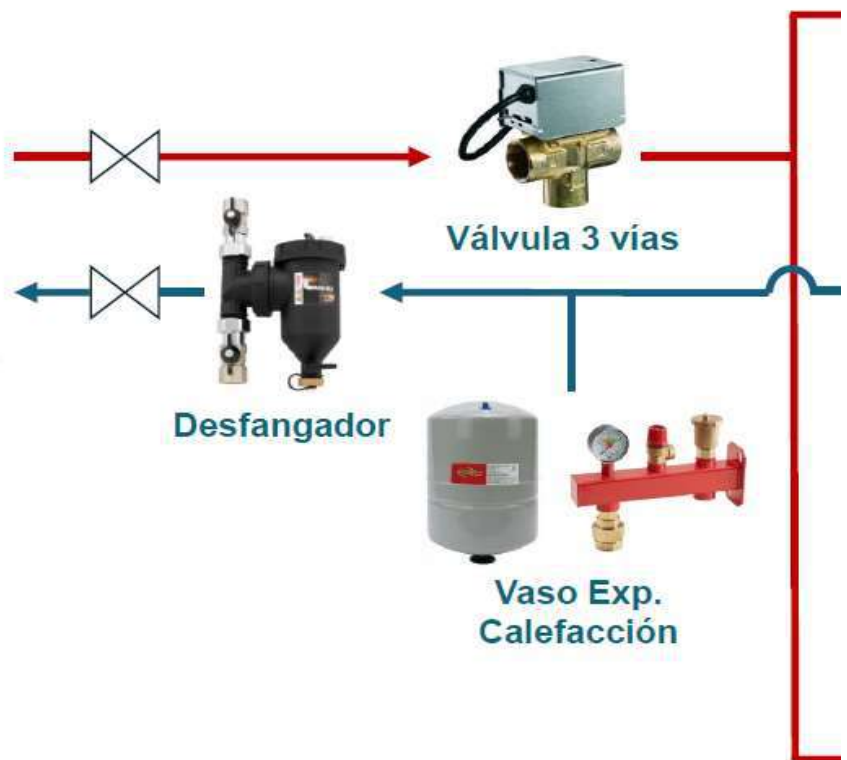



## AEROTERMIA

ALTA TEMPERATURA		REF.	€	REF.		€	
	AROTHERM PLUS CABLEADO				LASIAN		
	8KW	170917241	8.850,00		6 KW	171012006	4.200,00
	12 KW	170917242	11.725,00		10 KW	171012010	4.500,00
	15 KW	170917243	12.305,00		16 KW	171012016	6.500,00
				*OBLIGATORIO DESGASIFICADOR			

BAJA TEMPERATURA		REF.	€	REF.		€	
	NIMBUS POCKET			COMPLEMENTOS OBLIGATORIOS			
	50 M	580195103	4.977,00		KIT EXOGEL	580195102	191,00
	80 M	580195104	5.392,00		KIT VALV. Y FILTRO	580195101	90,00
	120 M	3301874	7.581,00				
150 M	3301876	7.964,00					





## ACUMULACION E INERCIA

	INTERACUMULADOR				100 lts.	170249971	1.010,00
	200 lts.	170214407	1.850,00		DEPÓSITO DE INERCIA		
	ES2 PURE C15-40/130			Honeywell	1"	180620100	123,90
	130mm	140615130	335,85	VÁLVULA DE 3 VÍAS	3/4"	180620101	123,90
	RACORES			Con contacto auxiliar		170254562	130,00
	1" x 1/2"	140618240	39,00		DEPÓSITOS DE INERCIA		
	CIRCULADORA DE ACS				(1) 50 lts. SLIM	581340001	451,00
	150 lts.	581340011	1.967,00		(2) 100 lts.	581340002	635,00
	INTERACUMULADOR						
	200 lts.	581340012	2.218,00				

## SOPORTES

	REF.	€		REF.	€
 <p>SOPORTE BASE ANTI VIBRANTE</p>	600 mm				
	180460003	83,47	 <p>KIT 4 ANTIVIBRANTES ROJO PARA V.EXTERIOR</p>	060300024	35,49

## ELEMENTOS PROTECCION PARA CALEFACCION Y ACS

 <p>CALEFACCIÓN 3/4-5 bar</p> <p>membrana no recambiable</p>	Lts.			 <p>SOPORTE VASO EXPANSION (CALEFACCIÓN)</p>	
	5	141805343	25,41		
	8	141808343	26,52		
	12	141812343	27,74		
	18	141818343	31,10		
 <p>ACS 3/4-10 bar</p> <p>membrana no recambiable</p>	5	141805012	28,80	 <p>SOPORTE VASO EXPANSION (ACS)</p>	
	8	141808012	32,04		
	11	141811012	35,70		
	18	141811018	38,90		
				141804098	92,00
				141804097	92,00

## VASOS DE EXPANSION SIN MANTENIMIENTO



 <p>CALEFACCIÓN</p>	8 lts.	141855073	51,30	 <p>ACS</p>	8 lts.	141855069	73,15
	18 lts.	141855071	63,35		12 lts.	141855070	83,25
	24 lts.	141855072	78,40				

## DESGASIFICADOR

	1"	180423086	147,25
	1" 1/4	180423087	176,15
 <p>DESFANGADOR VORTEX</p>	250		
	3/4"	180460022	127,40
	300		
	3/4"	180460024	140,90
	500		
	1"	180460025	193,78

 <p>VÁLVULA SEGURIDAD</p>	CALEF.		
	HH1/2 x 3Kg	180411001	9,70
	ACS		
	HH1/2 x 6Kg	180411003	9,70
	CALEF.		
	HH3/4 x 3Kg	180411011	16,40
ACS			
HH3/4 x 6Kg	180411013	16,40	
ACS			
HH3/4 x 8Kg	180411016	20,75	

## BOMBAS CIRCULADORAS

 <p>CIRCULADORA CALEFACCION FYCE</p>	ES 25-60 130mm	140625130	219,93	 <p>CIRCULADORA CALEFACCIÓN DAB</p>	EVOSTA 3 60-180		
	ES 25-60 180mm	140625180	241,92		140480506	356,00	
	ES 32-60 180mm	140632180	219,93		EVOSTA 3 60-180		
	ES 25-70 180mm	-			140480505	471,00	
	RACORES 1"1/2x1"	140618241	10,88		EVOPLUS 80/180M		
	RACORES 2"x1"1/4	140618242	16,50		140450940	928,00	
				KIT RACORES			
				1"1/2 x 1"	140421060	20,00	

## SUELO RADIANTE (AUTOFIJACIÓN)

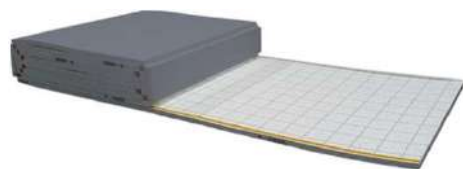

KLETT AUTOFIJ. NEOROL G

- Rollo 10 m<sup>2</sup>
- 0,75 m<sup>2</sup>K/W
- Espesor --> 25 mm
- Cert. AENOR (UNE-EN 1264)

REF. €

024035788 29,60



KLETT AUTOFIJ. EXTRA EPS

- Rollo 10 m<sup>2</sup>
- 0,56 m<sup>2</sup>K/W
- Espesor --> 25 mm
- Según UNE-EN 1264

024033402 22,91



ROLLO AUTOFIJACIÓN

240 mts	624131600	3,94
640 mts	624131601	3,55



ZOCALO 50 mts.

024000352 3,25



COLECTORES  
CON CAUDALIMETRO

4	024035946	411,50
5	024035947	481,00
6	024035948	551,00
7	024035949	621,00
8	024035950	691,00
9	024035951	760,50
10	024035952	830,00



CAJA  
COLECTORES

(500) 2-5 sal	024038106	158,00
(700) 6-9 sal	024038107	185,00
(850) 10-11 sal	024038108	217,50
(1000) 12 sal	024038109	237,00

TAPA

(500)	024038110	195,00
(700)	024038111	198,00
(850)	024038112	209,00
(1000)	024038113	228,50



CABEZALES (230 V)  
CABEZALES (24V)

024078593	69,12
024078592	63,07



MEZCLADORA 3/4

180410421 122,22



FILM POLIETILENO  
200 mts.

024000357 330,00



CINTA 50 mts.

024035012 11,70

SUELO RADIANTE (AUTOFIJACIÓN)

REF.

€

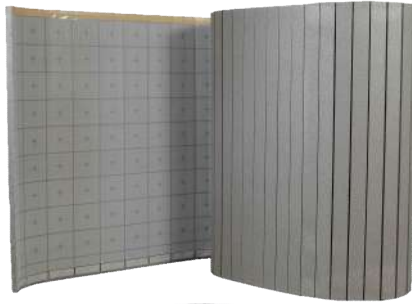

PANEL AISL. GRAFIKLETT  
AUTOFIJACIÓN

- Rollo 10 m<sup>2</sup>
- 0,77 m<sup>2</sup>K/W
- Espesor --> 25 mm

REF.	€
<b>SRPG23K</b>	<b>29,34</b>



KLETT PEX-A EVOH  
5 CAPAS

240 m	<b>PRETKEVR16</b>	<b>3,38</b>
640 m	<b>PRETKEVR16640</b>	<b>3,38</b>



BANDA PERIMETRAL ROLLO  
(rollo 50m)

<b>027490050</b>	<b>104,22</b>
------------------	---------------



KIT COLECTOR COMPACT PLUS

3	<b>SRKC3</b>	<b>416,40</b>
4	<b>SRKC4</b>	<b>481,72</b>
5	<b>SRKC5</b>	<b>530,71</b>
6	<b>SRKC6</b>	<b>571,54</b>
7	<b>SRKC7</b>	<b>661,35</b>
8	<b>SRKC8</b>	<b>710,34</b>
9	<b>SRKC9</b>	<b>759,33</b>
10	<b>SRKC10</b>	<b>808,32</b>
11	<b>SRKC11</b>	<b>898,13</b>
12	<b>SRKC12</b>	<b>938,95</b>



CAJA COLECTORES  
COLORBOX

(530) 2-6 sal	<b>027490065</b>	<b>143,27</b>
(680) 7-10 sal	<b>027490070</b>	<b>154,12</b>
(835) 11-12 sal	<b>027490075</b>	<b>192,21</b>



EUROCONO 3/4"	<b>SRADPEX16</b>	<b>4,82</b>
---------------	------------------	-------------



FILM BARRERA ANTIHUM.  
ROLLO (rollo 100m)

<b>027490055</b>	<b>247,16</b>
------------------	---------------



## SUELO RADIANTE (AUTOFIJACIÓN)



**PLACA N-MEDIAPLUS**  
 - 1330 x 890 mm  
 - 0,75 m<sup>2</sup>/K/W  
 - Espesor Total --> 49 mm  
 - Espesor Base --> 27 mm  
 - 8 Placas por caja (10,08 m<sup>2</sup>)

REF.

€

€/CAJA

N-MEDIAPLUS 75	253,44
----------------	--------



**TUBO PE-RT EVOH**

200 mts.	027320016	1,56
600 mts.	PERT16EVOHR600	1,56

€/Mto.  
Lineal

**ROLLO AUTOFIJACIÓN**

50 mts.	027300040	54,00
---------	-----------	-------



**COLECTORES  
CON CAUDALIMETRO**

CIRCUITOS

4	027300130	294,04
5	027300140	328,00
6	027300150	362,26
7	027300160	396,16
8	027300170	432,08
9	027300180	462,38
10	027300190	496,67
11	027300200	530,46
12	027300210	563,50



**CAJA  
COLECTORES**

4 (2 circ)	027300070	140,00
5 (3-4 circ)	027300080	159,00
6 (5-6 circ)	027300090	165,78
7 (7-8 circ)	027300100	175,32
8 (9-10 circ)	027300110	191,37
10 (11-12 circ)	027300120	213,65



<b>CURVA GUIA</b>	027300060	1,52
-------------------	-----------	------



**ACTUADOR TERMOELÉCTRICO**

027300220	37,00
-----------	-------



**ADITIVO PARA  
MORTERO 25 Kg**

027300030	124,00
-----------	--------



**FILM POLIETILENO  
125 m<sup>2</sup>**

027300020	144,00
-----------	--------

## RADIADORES DE ALUMINIO

Disponibles también en:  
350-600-700-800 €/ejes



MEDIDA (500 E/Ejes)		REF.	€
<b>3 ELEMENTOS</b>			
4	"	EUROPA 600C	540560003 70,62
5	"	EUROPA 600C	540560004 94,16
6	"	EUROPA 600C	540560005 117,70
7	"	EUROPA 600C	540560006 141,24
8	"	EUROPA 600C	540560007 164,78
9	"	EUROPA 600C	540560008 188,32
10	"	EUROPA 600C	540560009 211,86
11	"	EUROPA 600C	540560010 235,40
12	"	EUROPA 600C	540560011 258,94
		EUROPA 600C	540560012 282,48

## VALVULERIA

MEDIDA		REF.	€	MEDIDA		REF.	€
 <b>VÁLV. MANUALES</b>	- R/M 1/2	100307455	11,79	 <b>ARCO KIT CALEFACCIÓN CONJUNTA</b>	CU 15	100300015	22,71
	-Racor 16	100304392	5,94		MC 16	100300016	25,89
	-Soldar 15	100307439	11,88		RH 1/2	100300017	21,80
	- R/H 1/2	100307428	11,73				
	-15.1/2 (Compres)	100307457	13,19				
 <b>DETENTORES MANUALES</b>	- R/M 1/2	100307590	10,83				
	-Racor 16	100304392	5,94				
	-Soldar 15	100307577	10,93				
	- R/H 1/2	100307563	10,70				
	-15.1/2 (Compres)	100307592	12,69				

## VALVULERIA

MEDIDA		REF.	€	MEDIDA		REF.	€
 <b>PURG. MINI</b>	3/8"	180463801	8,44	 <b>SOPORTES REGULABLES</b> bolsa 2 uds	180491210	3,60	
	1/2"	180463802	12,96		 <b>JUNTA CONICA</b>	180404306	0,34
	 <b>PURGADOR AUTOMATICO C/ BOYA INCORPORADA</b>	1" Dcha.	180497106	13,48		 Tapón Ciego 1" dcha. 180495100 0,98 " " " izda. 180495101 0,98 Reducc. 1x1/2" dcha. 180491200 1,15 " " izda. 180492201 1,15 1x1/8" dcha. 180491800 1,15 izda. 180491801 1,15 <b>TAPONES</b>	
1" Izqda.		180497105	13,48				
 1  2	(1) 1/8"	180471803	7,00	 <b>NIPPLES</b>	180411102		0,53
	(2) 1/8"	180401806	0,83		 <b>ROSETA SIMPLE</b>		180421250
 <b>SOPORTE TERMOPLÁSTICO</b>		180494613	1,38	 - 2 reducc. 1"x. Dcha. con junta - 2 reducc. 1"x. Izda. Con junta - 1 purgador giratorio (1/2") - 1 tapón ciego (1/2") - 1 llavín cuadradillo para purgador <b>KIT RADIADOR</b>			180404305

## PROGRAMADORES Y TERMOSTATOS



RT310i

180815302

178,30 €



RT500RF

PROGRAMADOR INHALÁMBRICO

180815501

101,40 €



RT510

PROGRAMADOR CON HILOS

180815500

57,60 €



RT310RF

TERMOSTATO INHALÁMBRICO

180815301

92,30 €



RT310

TERMOSTATO CON HILOS

180815300

47,20 €



TERMOSTATO ANALÓGICO

180603079

28,70 €



TERMOSTATO DIGITAL

180601008

59,00 €



PROGRAMADOR T3 CON HILOS

180601006

98,20 €



PROGRAMADOR T3 INHALÁMBRICO

180620179

169,00 €



DELTA DORE PROGRAMADOR INHALÁMBRICO

180353007

243,00 €



PROGRAMADOR CUBE C/HILOS

164001116

91,00 €

PROGRAMADOR CUBE RF

164001118

110,00 €



RECEPTOR CUBE

164001120

110,00 €

## TOALLEROS BAÑO



TOALLERO BAÑO

		BL
80x45 e/ejes	540221260	99,00
118x45 e/ejes	540221245	147,95
80x45 e/ejes	540223080	219,14
118x45 e/ejes	540223120	273,65



KIT VÁLVULA Y DETENTOR CROMADOR CON BICONOS CU15 Y MC16

1/2 x CU 15	100300020	31,18
1/2 x MP 16	100300021	39,78



KIT VÁLVULA Y DETENTOR CROMADOR CON BICONOS CU15 Y MC16

540201521	59,00
-----------	-------

## AISLAMIENTO (K-FLEX)

MEDIDA	Mts/Caja	REF.	€
9/15	192	090409015	1,01
9/18	166	090409018	1,18
9/22	136	090409022	1,26
9/28	98	090409028	1,58
9/35	76	090409035	1,97
9/42	60	090409042	2,50
9/54	46	090409054	3,64
19/15	78	090419015	3,54
19/18	72	090419018	3,87
19/22	64	090419022	3,90
19/25	50	090419025	4,30
19/28	48	090419028	4,69
19/32	36	090419032	5,54
19/35	36	090419035	5,59
19/40	32	090419040	6,64
19/42	32	090419042	6,67
19/50	24	090419050	8,43
19/54	24	090419054	8,77
19/64	18	090419064	11,18
25/18	50	090425018	5,80
25/22	42	090425022	6,12
25/25	40	090425025	6,57
25/28	40	090425028	7,02
25/32	24	090425032	7,70
25/35	24	090425035	7,91
25/40	22	090425040	9,69
25/42	22	090425042	10,21
25/50	18	090425050	12,42
32/22	32	090403222	9,63
32/28	24	090403228	10,79
32/50	12	090403250	14,18
32/64	10	090403264	16,78
32/76	8	090403276	18,38
32/89	8	090403289	21,25
<b>Coquilla Blanca</b>			
20/22	50	090220022	9,02
<b>Coquilla polietileno PE</b>			
10/16	380	090601015	0,67
10/18	340	090601018	0,68
10/22	260	090601022	0,78
10/28	220	090601028	0,75
10/35	170	090601035	0,93
10/42	126	090601042	1,24
10/54	90	090601054	1,62
<b>Cinta 50x15</b>			
		080809115	20,44
<b>Adhesivo 500ml</b>		040223229	7,89



## CALDERAS

MEDIDAS (mm)

REF.

€

720x440x348 mm



Eco Tec Plus VMW 23CS/1-5 RADIO	161011665	2.750,00
Eco Tec Plus VMW 23CS/1-5	-	2.625,00

Eco Tec Plus VMW 26CS/1-5 RADIO	161011661	2.895,00
Eco Tec Plus VMW 26CS/1-5	161011660	2.825,00

Eco Tec Plus VMW 32CS/1-5 RADIO	161011659	3.495,00
Eco Tec Plus VMW 32CS/1-5	161011658	3.430,00

Eco Tec Plus VMW 36CS/1-5 RADIO	161011657	3.865,00
Eco Tec Plus VMW 36CS/1-5	161011656	3.790,00

### SOLO CALEFACCIÓN

Eco Tec Plus VM 25C S/1-5	161012630	2.920,00
Eco Tec Plus VM 30C S/1-5	161012631	3.135,00

Eco Tec Pure VMW 236/7-2 NAT	161009977	2.340,00
------------------------------	-----------	----------

Eco Tec Pure VMW 286/7-2 NAT	161009978	2.505,00
------------------------------	-----------	----------

CONTROL INALAMBRICO VRT 51f+ VR 940f CON WIFI	161035734	280,00
---	-----------	--------

720x440x335 mm



626x400x270 mm



CALDERA PUMA 18/24 NAT	162226122	2.300,00
------------------------	-----------	----------

CALDERA PUMA 24/28 NAT	162226123	2.650,00
------------------------	-----------	----------

PROGRAMADOR	162218084	175,00
-------------	-----------	--------



770x400x315 mm CALDERA CLAS ONE 24FF WIFI *Incluye kit evacuación	N	164001201	1.965,00
---	---	-----------	----------

770x400x315 mm CALDERA CLAS ONE 30FF WIFI *Incluye kit evacuación	N	164001202	2.219,00
---	---	-----------	----------

770x400x315 mm CALDERA CLAS ONE 35FF WIFI *Incluye kit evacuación	N	164001203	2.577,00
---	---	-----------	----------

# CALEFACCION

## CALDERAS

### ACCESORIOS CONDENSACION POLIPROPILENO

80

60/100

#### TRAMO



- Tramo 0,25 mts 

-		620980204	19,71
---	--	-----------	-------

- Tramo 0,5 mts 

620980500	7,94	620980206	22,41
-----------	------	-----------	-------

- Tramo 1 mto 

620981000	11,05	620980210	30,60
-----------	-------	-----------	-------



CODO 90°



CODO 45°

- Codo M-H 90° 

020900845	7,43	020980226	24,00
-----------	------	-----------	-------

- Codo M-H 45° 

020900890	7,97	020980224	24,45
-----------	------	-----------	-------



ABRAZADERA  
ACERO

- Abrazadera 100 

-		020400104	7,68
---	--	-----------	------

- Abrazadera 110 

-		020401004	8,20
---	--	-----------	------



Manguito T/ Muestras

- Manguito T/ Muestras 

-		022000090	36,39
---	--	-----------	-------



LUBRISIL

- Lubrisil 400 ml 

040271540	6,10		
-----------	------	--	--

### COMPLEMENTOS



AGUJA 1" 1/4  
SOPORTE

89 L/min 

027019005	142,00
-----------	--------

120 L/min 

027019006	189,00
-----------	--------



FILTRO MAGNETICO CALDERA 3/4

160951701	71,94
-----------	-------



KIT CONEXIÓN CALDERAS

160951700	62,00
-----------	-------



NEUTRALIZADOR CONDENSADOS

161096215	70,00
-----------	-------



BOMBA CONDENSADOS

561001007	133,00
-----------	--------



AMARIO 800x430x250

022000001	97,21
-----------	-------

ARMARIO 900x500x400

022000002	115,32
-----------	--------

ARMARIO 1000x550x440

022000003	124,63
-----------	--------

CALDERAS OIL

REF. €



MODELO AV

KALTERM AV 30A (100 L. vitri) 162598005 3.319,00

KALTERM AV 40A (100 L. vitri) 162598006 3.498,00



MODELO A

KALTERM 30A (27Kw) 162598001 2.430,00

KALTERM 40A (36Kw) 162598003 2.717,00

PROTECCIÓN Y MANTENIMIENTO

REF. €



Limpiar



Proteger



Mantener



LIMPIADOR DE SUPERFICIES

181374002

40,44



DESELODADOR Y DISPERSANTE

181374003

42,24



DESELODADOR RAPIDO

181374004

43,52



INHIBRIDOR ANTICORROSION

181374000

44,04



ANTICONGELANTE

181374011

417,64



BIOCIDA NO OXIDANTE

181374022

71,98



LEAK SELLADOR

181374024

33,45



## CALENTADORES

REF.

€



580x350x198 mm

**ESTANCO PLUS**  
\*Incluye kit evacuación

Natural 12 lts	<b>201013001</b>	<b>900,00</b>
Natural 15 lts	<b>201013004</b>	<b>970,00</b>
Natural 17 lts	<b>201013005</b>	<b>1.035,00</b>



627x348x240 mm

**ESTANCO PRO**  
\*Incluye kit evacuación

Natural 12 lts	<b>201073026</b>	<b>790,00</b>
Butano 12 lts	<b>201073028</b>	<b>790,00</b>
Natural 14 lts	<b>201073029</b>	<b>860,00</b>
Butano 14 lts	<b>201073031</b>	<b>860,00</b>





590x310x246 mm

**ATMOSFÉRICO**

Natural 11 lts	<b>201011312</b>	<b>610,00</b>
Butano 11 lts	<b>201011311</b>	<b>610,00</b>

## CALENTADORES

			REF.	€
 <p>NEXT EVO</p>	11 Lts.	BUTANO	200132166	480,00
	570x345x165 mm			
	11 Lts.	NATURAL	200132167	480,00
	16 Lts.	BUTANO	200132171	578,00
	570x345x187 mm			
	16 Lts.	NATURAL	200132170	578,00

 <p>ATMOSFÉRICO</p>		BUTANO	200132165	347,00
	617x310x211 mm			
		NATURAL	200132164	347,00

## ESTANCO COAXIAL 60/100

	TRAMO M-H (1 mto.)	620766111	30,27		CODO M-H 45°	020727111	30,32
	TRAMO M-H (0,5 mts.)	620766125	20,00		CODO H-H 45°	020719045	28,65
	TRAMO M-H (0,25 mts.)	620766110	14,30			Manguito T/ Muestras	022000099
	60/100	020713040	26,24			LUBRISIL 400 ml	040271540
	CODO M-H 90°	020719240	23,81			MANGUITO	020727125
	CODO H-H 90°	020719040	26,22				

## TERMOS ELÉCTRICOS

CAPACIDAD (l) POTENCIA (W)

€



5 años garantía total  
Eficiencia energética clase B  
Doble resistencia envainada  
Anodo magnesio grandes dimensiones

### PRO 1 ECO DRY MULTIS

SLIM 30	580116030	30	2x800	610x353x373	360,00
SLIM 50	580116050	50	2x900	874x353x373	376,00
80	580116080	80	2x900	758x450x470	417,00
100	580116100	100	2x900	913x450x470	459,00

PRO ZEN 150	580110150	150	1800	1020x560x575	682,00
PRO ZEN 200	580110200	200	2200	1280x560x575	779,00

TRIPODE TERMO	580110001	50,00
---------------	-----------	-------

580110010	SOPORTE UNIVERSAL TERMO	58,00
-----------	-------------------------	-------



ANDRIS 15l	1200	580118015	360x360x324	202,00
------------	------	-----------	-------------	--------

ANDRIS 30l	1500	580118030	447x447x389	233,00
------------	------	-----------	-------------	--------



3 años garantía total / 5 años en calderín  
Eficiencia energética clase B  
Doble resistencia blindada antical  
Termostado electrónico  
Vertical - horizontal

VELIS WIFI 50	1500	580140050	776x506x275	493,00
---------------	------	-----------	-------------	--------

VELIS WIFI 80	1500	580140080	1066x506x275	596,00
---------------	------	-----------	--------------	--------

VELIS WIFI 100	1500	580140100	1251x506x275	668,00
----------------	------	-----------	--------------	--------

## TERMOS ELÉCTRICOS

CAPACIDAD (l) POTENCIA (W)

€



### ELOSTOR EXCLUSIVE

2 años garantía total /  
3 años en calderin

581575055	50	1'2 + 0'8	470 - 860 mm	575,00
-----------	----	-----------	--------------	--------

Doble tanque

Panel táctil

Clase B

Autoaprendizaje

Doble Resistencia envainada

581575085	80	1'2 + 0'8	570 - 910 mm	685,00
-----------	----	-----------	--------------	--------

581575100	100	1'2 + 0'8	570 - 1095 mm	755,00
-----------	-----	-----------	---------------	--------

\*vertical - horizontal



### ELOSTOR PLUS

(3 AÑOS)  
(VERTICAL)

Panel táctil

Clase B

Autoaprendizaje

Percha universal

Anodo de gran tamaño

581576050	50	2 KW	450 - 590 mm	370,00
-----------	----	------	--------------	--------

581576080	80	2 KW	450 - 815 mm	440,00
-----------	----	------	--------------	--------

581576100	100	2 KW	450 - 1000 mm	475,00
-----------	-----	------	---------------	--------

581576030	30	1,5 KW	340 - 620 mm	305,00
-----------	----	--------	--------------	--------

581576055	50	2 KW	385 - 756 mm	405,00
-----------	----	------	--------------	--------

581576085	80	2 KW	385 - 1024 mm	465,00
-----------	----	------	---------------	--------



Resistencia envainada

Vertical - horizontal

Antical

581348550	50	2x800	608x440x468	340,36
-----------	----	-------	-------------	--------

581348580	80	2x800	858x440x468	384,40
-----------	----	-------	-------------	--------

581348510	100	2x1200	998x440x468	437,52
-----------	-----	--------	-------------	--------



Resistencia blindada

Clase C

Vertical

30	581347330	1200	555x353x380	153,00
----	-----------	------	-------------	--------

50	581347350	1500	593x440x468	165,00
----	-----------	------	-------------	--------

80	581347480	1500	843x440x468	195,00
----	-----------	------	-------------	--------

100	581347510	1500	983x440x468	223,00
-----	-----------	------	-------------	--------

150	581347515	2000	1257x440x468	406,00
-----	-----------	------	--------------	--------

## AEROTERMIA

CAPACIDAD (lts)

REF.

€



Deposito INOX  
Gas R. 290  
5 Años Garantía total

1458x634mm 200 lts. (suelo)	170226816	3.070,00
1783x634mm 270 lts. (suelo)	170226817	3.325,00



Calderin Acero Vitrificado  
Gas R. 290  
2 Años Garantía total,  
ampliable a 3



1176x520mm NUOS PLUS S2 WIFI 80	580195080	1.679,00
1403x520mm NUOS PLUS S2 WIFI 110	580195110	1.795,00
1659x520mm NUOS PLUS S2 WIFI 150	580195150	1.921,00
TRIPODE NUOS (110-150)	580110002	50,00
1737x680mm 200 lts. (suelo) PLUS	580197200	3.107,00
1706x614mm 200 lts. (suelo)PRIMO	580196200	2.469,00
1997x680mm 250 lts. (suelo) PLUS	580197250	3.358,00
Grupo Seguridad	580198085	33,00
Sifón	580198086	6,00



AEROMAX ACCES

1234x539mm	100 lts. (mural)	170500001	1.711,50
1557x539mm	150 lts. (mural)	170500002	1.897,44
1609x665mm	200 lts. (suelo)	170500003	3.027,55
1180x575mm	200 lts. (suelo)	170500004	2.630,00
1949x665mm	270 lts. (suelo)	286043	3.090,00

\* NO APTO PARA OBRAS

Número de dormitorios

1 2 3 4 5 6 ≥6

Número de personas

1,5 3 4 5 6 6 7

Litros ACS

42 84 112 140 168 168 196

## SOLAR

REF.

€



FYCE 150 lts.	162598099	1.781,00
FYCE 200 lts.	162598098	2.055,00
LÍQUIDO SOLAR 10L.	170202363	60,00
LÍQUIDO SOLAR 20L.	170202498	110,00
VÁLVULA MEZCLADORA 3/4	570800117	113,02

# # POR QUÉ # ESPERAR

para instalar las  
soluciones de  
climatización  
más eficientes  
e inteligentes?



R290  
NATURAL  
REFRIGERANTE

H2 ready  
100% H2 compatible



## Descubre la nueva generación de climatización Vaillant

Tanto si eliges una nueva caldera inteligente con la tecnología más innovadora o el más eficiente y sostenible sistema de aerotermia con refrigerante natural, **ayudas a tus clientes a reducir al mínimo las emisiones de CO<sub>2</sub> y también su factura energética.**

#Whywait #Porquéesperar?  
Solicita información en [vaillant.es](https://vaillant.es)

 **Vaillant**  
Confort para mi hogar

## SPLIT MURAL



REF. €



VAIL 1-025 (2700w)	
062224452	760,00
VAIL 1-030 (2700w)	
062224453	805,00
VAIL 1-045 (2700w)	
062224454	1.300,00

## COMPLEMENTOS



REF. €



CAJA PREINSTALACIÓN

060300011	12,48
-----------	-------



KIT SIFÓN SECO MINI

060300025	31,20
-----------	-------

## BOMBAS



EXTERNA 38 L/H

INTERNA 13 L/H

EXTERNA 40 L/H



060300022  
98,80

060300027  
93,47

060300023  
118,80

## SPLIT MURAL PULAR



Tuberías frigoríficas 3/8x1/4

	REF.	€
9 R32 (2,5kw)	060200012	955,00
12 R32 (3,5 kw)	060200010	976,32
18 R32 (4,6 kw)	060200013	1.569,42

## CONDUCTOS U-MATCH

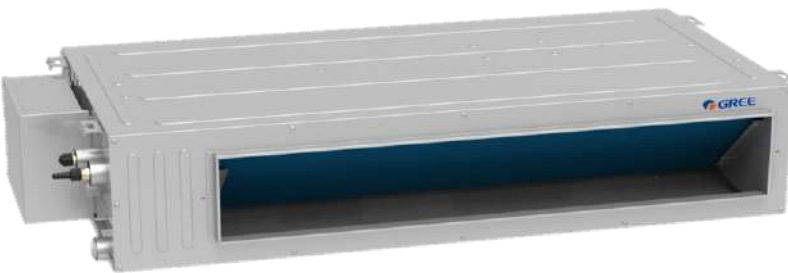

Tuberías frigoríficas 5/8x3/8

	REF.	€
UM CDT 24 R32 (7kw)	060200101	2.717,00
UM CDT 30 R32 (8,5kw)	060200102	3.330,00
UM CDT 36 R32 (10kw)	060200103	3.952,00
UM CDT 42 R32 (12kw)	060200104	4.574,00
UM CDT 48 R32 (13,4kw)	060200105	5.082,00

## FANCOILS

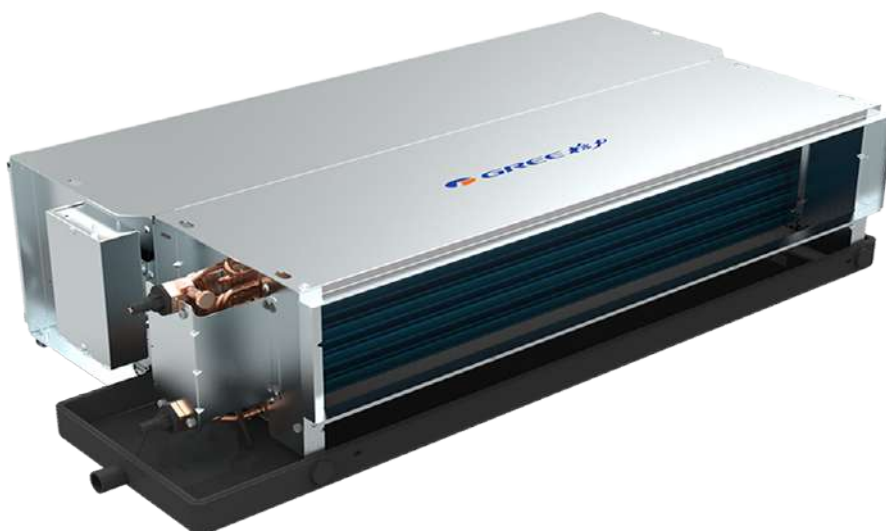

	REF.	€
CDT 86 (3/4) 8,5kw	060200301	796,10
CDT 105 (3/4) 10,5kw	060200302	860,70



**TUBERÍA Y CANALETA**

REF. €



TUBERÍA AISLADA (20mts)

1/4 x 3/8	060401421	201,86
*1/4 x 1/2	060401422	248,31



CANALETA (Tramo 2 mts.)

		€/metro
65x50mm	060300001	6,24
90x65mm	060300002	8,72



ÁNGULO INTERNO

65x50mm	060300003	5,20
90x65mm	060300004	6,50



ÁNGULO EXTERNO

65x50mm	060300005	5,20
90x65mm	060300006	6,50



TAPÓN FINAL

65x50mm	060300007	4,68
90x65mm	060300008	6,50



CURVA PLANA

65x50mm	060300009	5,46
90x65mm	060300010	7,41

**SOPORTES Y ANTIVIBRADORES**

REF. €



**SOPORTE PARED**

450x450mm **060300016** 29,77

500x500mm **060300017** 32,24

\*520x400mm **060300018** 53,56

\*Especial aeroterminia



**SOPORTE BASE ANTI VIBRANTE**

450 mm **180460002** 68,25

600 mm **180460003** 83,47



**KIT 4 ANTIVIBRANTES ROJO PARA V.EXTERIOR**

**060300024** 35,49



**ANTIVIBRADORES**  
Juego 4 uds.

**060300019** 11,57



**ANTIVIBRADORES SUELO**  
Juego 4 uds.

**060300020** 13,65



**SOPORTE BASE**  
Juego 4 uds.

**060300015** 47,19





	REF.	€		REF.	€
 <p>FILTRO ALASKA C/. VALV.</p>	400		 <p>BOMBA STARPUMP</p>	1/2 cv	
	52500026	366,76		52550027	254,68
	500			525500677	259,31
	525540004	413,96		1 cv	
				525500678	290,83
	600			1,5 cv	
	525540006	440,50	 <p>BOMBA KSE</p>	3/4 cv	
				525000006	421,66
				1 cv	
				525000007	448,79
 <p>ARENA SILEX SACO 25Kg.</p>	526000596	19,75	 <p>VIDRIO FILTRANTE 25 Kg.</p>	526000644	27,62

ELECTRÓLISIS SALINA





	525000020	525000002			
	Descripción	AQRLTOSOV16	AQRLTOSOV22	AQRLTOSOV33, AQRLTOSOV50	
	Volum. m3	60	90	115	180
	PVP (€)	966,41	1.043,51	1.226,24	1.900,32
	SAL EN ESCAMAS	600400038	11,70		
	KIT PH + BOMBA PERISTALTICA	525000004	348,52		
	REDUCTOR PH LÍQUIDO	525000018	36,93		





**MATERIAL VASO PISCINA**

REF.		€	REF.		€
		<b>525500183</b>	<b>50,85</b>		
SKIMMER				BOQUILLAS IMPULSIÓN	
		<b>525500170</b>	<b>19,36</b>		
SUMIDERO CUADRADO				BOQUILLAS ASPIRACIÓN	
		<b>525500171</b>	<b>15,71</b>	<b>525500274</b>	
SUMIDERO CIRCULAR				<b>5,64</b>	
REF.		€	REF.		€
		<b>525500065</b>	<b>8,53</b>		
DOSIFICADOR CLORO-BROMO PH				LIMPIAFONDOS ELÉCTRICO S-200	
QP				<b>525000005</b>	
				<b>1.397,46</b>	
(1) 	(2) 	(3) 	(1) <b>525000015</b>		
DUCHA SOLAR G25L	DUCHA INOX	DUCHA INOX + LAVAPIES	<b>264,70</b>	MANGUERA 10 mts. CON MANGUITO	
			(2) <b>525000024</b>	<b>37,46</b>	
			<b>307,56</b>	<b>525000025</b>	
			(3) <b>525000023</b>	<b>4,44</b>	
			<b>253,22</b>	RACORD CONEXIÓN	
		<b>525000017</b>	<b>9,02</b>		
KIT ANÁLISIS OTO Y PH					

REF.		€	REF.		€
 <p>CASETA ENTERRADA</p>	ALASKA 500 + STAR 0,75 CV		BLANCO	525000013	90,43
	525000001	1.532,19	13.5 W		
 <p>CASETA SEMIENTERRADA</p>	ALASKA 600 + STAR 1 CV		LÁMPARA LED C/MANDO		
	525000022	1.602,24	COLOR	525000014	112,10
 <p>CUADROS ELECTRICOS 0-3 CV HAYWARD</p>	ALASKA 500 + STAR 0,75 CV		14 W		
	525000000	1.522,92	BLANCO	525000011	128,47
 <p>CON TRAFIO 50 W</p>	CON TRAFIO 50 W		10 W		
	525000009	347,34	PROYECTOR LED EXTRAPALNO C/MANDO		
 <p>SIN TRAFIO</p>	SIN TRAFIO		COLOR	525000012	148,31
	525000008	254,47	14 W		

RIEGO

	REF.	€
		
4 ESTACIONES INTERIOR	441019683	139,09
6 ESTACIONES INTERIOR	441019684	156,97
4 ESTACIONES EXTERIOR	441019686	216,51
6 ESTACIONES EXTERIOR	441019687	249,34
<b>ELECTROVÁLVULAS 1"</b>		
		
(24V)	441016114	26,83
(9V)	441016118	35,13
<b>DIFUSORES Hunter®</b>		
		
(5cm)	441019590	3,76
(10cm)	441019596	3,92
<b>ASPERSORES Hunter®</b>		
		
(1/2")	441014004	17,41
(3/4")	441014125	19,69
<b>ARQUEUTAS</b>		
		
(27x39cm)	441012674	43,33
(43x60 cm)	441012675	60,76

	REF.	€
	441010333	44,94
<b>9V 1 ESTACIÓN</b>		
	441011079	106,53
<b>COLLARINES</b>		
		
(20x1/2")	023698000	2,09
(25x1/2")	026398001	1,94
(25x3/4")	026398002	2,09
(32x1/2")	023698003	2,97
(32x3/4")	023698004	2,76
(32x1")	023698005	2,84
		
(2 salidas)	441011858	12,06
(3 salidas)	441011859	19,47
(4 salidas)	441011860	25,68
<b>COLECTORES</b>		
		
<b>TUBERIA GOTEO</b>		
(16mm R. 50 mts.)	440614018	10,00
(16mm R. 100 mts.)	440614019	18,30
(16mm R. 100 mts.)	*440614030	31,20
*Con goteo integrado		

## SIMPLE FLUJO

	REF.	€		REF.	€
<p>COMFOFAN SILENT 425 CONTROL RFZ</p>	180500030	334,36	<p>JUNTA DE 90 (Bolsa 10 uds.)</p>	180500018	19,46
	180500022	469,14		<p>REJILLA EXTERIOR DN125 DN160</p>	180500001
<p>COMFOTUBE 90 (R 50 mts)</p>	180500032	388,19	<p>REJILLA REDONDA MULTI 90-125mm</p>	300282852	3,73
	<p>SILENCIADOR CW4 CW6 CW8</p>	180500011		228,78	<p>FLEXIBLE SIN AISLAR DN125 DN160</p>
<p>PLACA CONEXIÓN CW4 CW6 CW8</p>	180500007	59,62	<p>ESPIROFLEX COMPACTO *Bolsa 3 mts.</p>	991328610	
	<p>PLACA DISTRIBUCIÓN 90x4 90x6 90x8</p>	180500008		76,67	991328611
<p>PLENUM TVA-P 90 (1) (2) (3)</p>		180500009	80,31	991328612	17,15
	<p>REJILLA RETORNO STH-STC</p>	180500019	30,43	991328600	6,28
<p>REJILLA LUNA</p>		180500029	24,34	991328601	6,91
	<p>EXTRACCION (E)</p>	180500027	24,34	991328602	7,53
<p>IMPULSIÓN (S)</p>		180500020	19,46	991328604	11,59
	<p>180500028</p>	180500021	33,09	*Minimo 5 mts.	
<p>180500021</p>		060300032	7,02	€ / mts	
	<p>180500021</p>	060300033	8,06	€ / mts	
			<p>FLEXIBLE AISLADO (10 mts.)</p>		

## SIMPLE FLUJO

	REF.	€		REF.	€
 <p><b>EASYHOME AUTO COMPACT</b></p>	11026034	271,00	 <p><b>EXTRACTOR BAÑO</b></p>	280221010	34,00
 <p><b>TUBO FLEXIBLE ROLLO 50m</b></p>	$\varnothing 75$ 75VMCFLEX	216,00	 <p><b>REJILLA PLÁSTICO VERTICAL Y CIERRE C/MARCO</b></p>	300282850	7,02
 <p><b>SALIDA VERTICAL TECHO</b></p>	$\varnothing 75$ ENTRADA $\varnothing 125$ SALIDA ST1x75C	59,02	 <p><b>MOSQUITERO</b></p>	300282851	1,90
 <p><b>REJILLA PARA EXTRACCIÓN</b></p>	$\varnothing 125$ VS125	22,91	 <p><b>REJILLA FACHADA CON MOSQUITERA</b></p>	160DFHREJAL	21,00
 <p><b>REJILLA PARA IMPULSIÓN/EXTRACCIÓN</b></p>	$\varnothing 125$ VSE125	22,91	 <p><b>TUBO FOAM (2m)</b></p>	160-2000FOAM	103,28



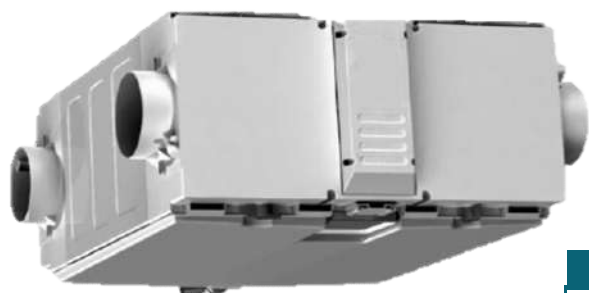

COMFOAIR COMPACT  
CA155CM

### INFORMACIÓN

Medidas (H x W x D)	320 x 636 x 752,5 mm
Rango de Caudal de aire m <sup>3</sup>	de 36 m <sup>3</sup> /h s 254 m <sup>3</sup> /h
Habitaciones Húmedas	Máx. 6 cuartos secos y 6 húmedos
Superficie	Aproximadamente 150 m <sup>2</sup>

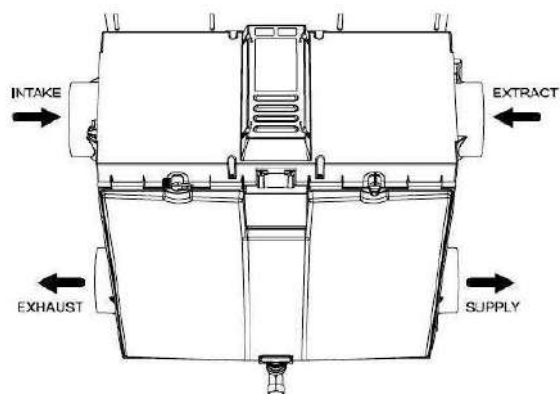

**\*PARA VIVIENDAS CON MÁS CUARTOS HÚMEDOS CONSULTAR AL DEPARTAMENTO TÉCNICO: [tecnico@suministrosplasa.com](mailto:tecnico@suministrosplasa.com)**





# LA REFERENCIA.



R290

NATURAL  
PERFORMANCE







## La referencia en eficiencia, sostenibilidad y confort. aroTHERM plus de Vaillant

-  La primera del mercado en utilizar tecnología de refrigerante natural con un PCA muy bajo
-  Clase A+++ y el mejor rendimiento en ACS del mercado
-  La más silenciosa de su categoría









[www.vaillant.es](http://www.vaillant.es)  
Calefacción. Energías renovables. Hogares inteligentes.

 **Vaillant**  
Confort para mi hogar









**GAS BUTANO**

	REF.	€		REF.	€	
	16 - 18	100504902	0,77			
<b>ABRAZADERA</b>						
	(30 mbar) BUTANO	991350759	17,52			
	(50 mbar) PROPANO	991350760	21,07			
<b>REGULADOR</b>						
	10	100502902	0,77			
	12	100502903	1,00			
<b>BOQUILLA SOLDAR</b>						
					991350757	3,27
				<b>GOMA BUTANO</b>		
					991350758	8,93
				<b>TUBO BUTANO KIT 1'5 mts +ABRAZADERAS</b>		
					360312567	11,21
				<b>LIRA 70 cm</b>		

**GAS NATURAL**

	REF.	€		REF.	€	
	15.15 CR	100505201	0,76			
	17.17 CR	100505209	1,38			
	17.17 BL	100505211	2,79			
	18 x 7/8	360313368	11,85			
	22 x 7/8	360313369	10,08			
	18 x 1/2	021606163	9,50			
	15 x 1/2	021606162	8,89			
	18 x 3/4	021606193	9,08			
<b>RACOR C/ Toma</b>						
	M 1/2	360357100	18,52			
<b>LLAVE CON LIMITADOR CAUDAL</b>						
		360313398	66,70			
<b>SOPORTE CONTADOR INOX XON RACORES 7/8</b>						
		360313399	12,98			
<b>ACOPLAMIENTO LATERAL</b>						
					360309011	28,12
				<b>REGULADOR</b>		
				3/4 M - 7/8		
					240403120	12,72
				<b>GASLINK HH 1/2</b>		
				20 cm		
				30 cm	240403130	14,00
				50 cm	240403121	18,11
					240403220	16,36
				<b>GASLINK HH 1/2 x 3/4</b>		
				20 cm		
				30 cm	240403230	16,89
					240106509	67,15
				<b>GASLINK C/ Valv. Seguridad</b>		
				100 cm		

**GAS MULTICAPA (32 Kn/cm<sup>2</sup>) PERFIL RFZ**

BARRA (4 METROS)			REF.	€	REF.			€	
		€/BARRA							
	20	627400020	17,86		20	027400090	6,32		
	25	627400025	30,06		25	027400091	11,36		
<b>CODO</b>					<b>TE</b>				
	20	027400010	4,45			20	027400100	3,47	
	25	027400011	7,78			25	027400101	6,29	
<b>ENLACE R. HEMBRA</b>					<b>UNIÓN</b>				
	20 - 1/2	027400031	3,53			20	027400060	3,54	
	20 - 3/4	027400030	4,31			25x20	027400061	5,23	
	25 - 3/4	027400032	5,29			<b>REDUCCIÓN</b>			
<b>ENLACE R. MACHO</b>					<b>SEGURIDAD TÉRMICA</b>				
	20 - 1/2	027400041	3,26			3/4 HH	027400020	38,42	
	20 - 3/4	027400040	4,34			<b>LIMITADOR CAUDAL</b>			
	25 - 3/4	027400042	5,03				4M x 3H	027400050	85,63
<b>RACOR MOVIL C/TOMA PRESIÓN DÉBIL</b>									
	20x1/2	027400080	7,22						
	20x3/4	027400081	8,11						
	20x7/8	027400082	8,00						
	25x3/4	027400084	10,00						
	25x7/8	027400083	8,96						
<b>RACOR MOVIL PRECINTABLE</b>									
	20x1/2	027400070	4,32						
	20x3/4	027400071	5,19						
	20x7/8	027400072	8,54						
	25x7/8	027400073	5,68						

SERIES DE PORCELANA ROCA

	MEDIDA	REF.	€
 <p>VICTORIA</p>	Lavabo 52	560210048	44,90
	Lavabo 56	560210051	51,00
	Lavabo 65	560210050	56,90
	Pedestal	560210052	39,70
	Semipedestal	560210049	36,80
	Taza S/V	560210055	67,80
	Taza S/H	560210056	67,80
	Depósito a/lateral	560210057	116,00
	Depósito a/inferior	560210053	116,00
	Asiento	560210059	49,20
 <p>THE GAP (compacto)</p>	Bidé	560210060	62,80
	TAPA Bidé	560210077	53,80
	Taza S/dual	560270255	161,00
	Depósito A/Inf	560270053	158,00
	Depósito A/Lateral	560270052	158,00
	Asiento	560270259	65,30
	Asiento amortiguado	560270258	122,00
	Bidé	560270260	120,00
	Tapa Bidé	560270061	57,30

REPUESTOS ROCA

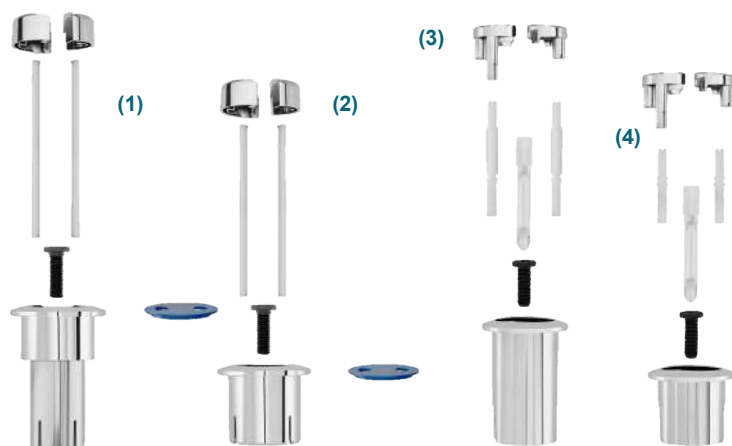

CONJUNTO DOBLE PULSADOR 3/6 LITROS (tapa 40 Ø)		
(1)	CONJUNTO PULSADOR LARGO VARILLA RECORTABLE PARA D1D	
	560208703	14,10
(2)	CONJUNTO PULSADOR CORTO VARILLA RECORTABLE PARA D1D	
	560208704	13,40
(3)	CONJUNTO PULSADOR LARGO VARILLA ROSCABLE PARA D2D	
	560208711	13,60
(4)	CONJUNTO PULSADOR CORTO VARILLA ROSCABLE PARA D2D	
	560208712	12,90

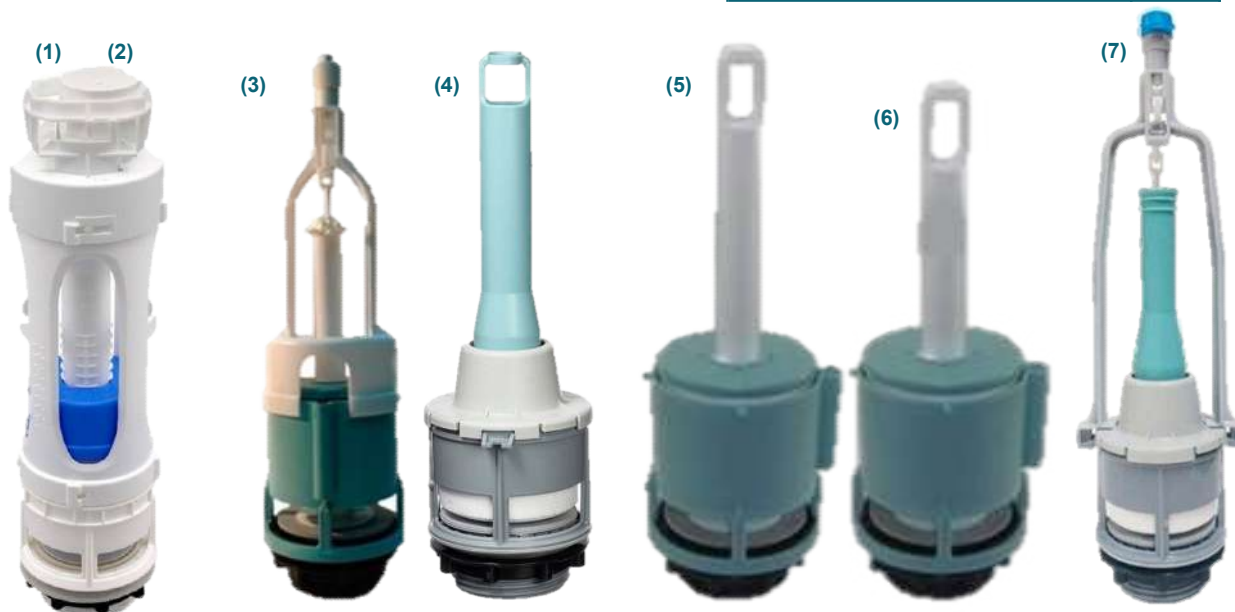

**MECANISMOS DESCARGA**

(1)	D1D para doble pulsador (varilla recortable)		560208710	31,30
(2)	D2D para doble pulsador (varilla rosacable)		560208700	30,60
(3)	D1P con tirante guía para pulsador enrasado y elevado		560208701	30,10
(4)	D4T tirador interrumpible	Victoria	560208702	26,60
(5)	D1T tirador no interrumpible	Meridian, Gondola, Lorentina, Carena, Lucerna, Estudio	560207650	28,50
(6)	D3T tirador no interrumpible	Victoria, Dama, Aquaria, Liberty	560207630	28,50
(7)	Mecanismos de descarga D2P con tirante para pulsador enrasado	Victoria	560207640	28,00



**TIRANTE GUÍA**

(1)	Para descarga D4T	560208600	3,21
(2)	Para descarga D1T	560208622	3,04
(3)	Para descarga D3T	560208610	3,42

REPUESTOS ROCA

MEDIDA REF. €



BISAGRAS ACERO VICTORIA

560201655 14,30



BISAGRAS DAMA

560201622 9,68



BISAGRAS DAMA S - GIRALDA

560200210 10,20



560200250 4,10

FIJ. BISAGRA DAMA S - GIRALDA



BISAGRA AMORTIGUADA (Todas Series)

560201612 81,80



KIT JUNTA TAZA DAMA SENSO C

560207300 6,33



KIT JUNTA TAZA VICTORIA

560207400 5,94

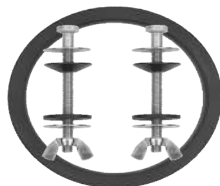

KIT JUNTA TAZA (Resto Series)

560208000 6,50



JUNTA PLANA

560205674 2,66



CONJUNTO PULSADOR ENRASADO

Para descarga D1P y D2P  
Victoria, Dama,  
Veronica, Liberty

(1) 560207683 12,00

Para descarga D1P

Meridian, Sidney, Georgia

(2) 560208707 13,30

COMPACT: Alimentación inferior

Mecanismo de alimentación A4I\_m, entrada inferior con rosca metálica. Compacto y llenado rápido

560207670 22,40

COMPACT: Alimentación lateral

Mecanismo de alimentación A4I\_m, entrada lateral con rosca metálica. Compacto y llenado rápido

560200680 18,70



MECANISMO UNIVERSAL ROCA DESCARGA DOBLE

Mecanismo de doble descarga D2D N (6/3 O 4,5 litros) con dos pulsadores (estrecho y ancho)

ACCESS, AMERICA, CIVIC, DAMA, DEBBA, ELEMENT, GEORGIA, GIRALDA, HALL, HAPPENING, INSPIRA, LIBERTY, MERIDIAN, SIDNEY, THE GAP, VERANDA, VERONICA, VICTORIA, BEYOND, INSPIRA

560202100 38,90

MECANISMO UNIVERSAL ROCA DESCARGA SIMPLE

Mecanismo de descarga simple D2P (6 litros interrumpible) con 4 pulsadores (cortos y largos, diámetro 27 y diámetro 40)

ELEMENT, AMERICA, HAPPENING, HALL, MERIDIAN, DAMA, GIRALDA, VICTORIA, GEORGIA, VERANDA, CIVIC, VERONICA, SYDNEY, THE GAP, LIBERTY, DEBBA

560202200 31,70



**COMPLEMENTOS WC**

	REF.	€		REF.	€
 <p>MANGUITO WC Extensible</p>	(100mm - 160mm)			DAKOTA 110(15cm)	991364997 11,57
	991303130	16,12		110 (21 cm)	991393050 16,53
	(140mm - 290mm)			MANGUITO WC Dual	
	(310mm - 860mm)				
	991303133	17,82			
	110	991304040 7,61		90	991304010 5,04
				110	991364981 5,22
	DUALFLESS			110	991364983 5,36
	110	991364991 21,36			(2cm) exc.
	TIGRIS			110	991364982 5,33
	110	991302081 32,94			(4cm) exc.
	KILLIN			110	991362080 12,59
	110	991364986 6,32			(8cm) exc.
	LUGANO			90/110 EXCÉNTRICO	991364999 11,20
	(250mm - 400mm)			90/110 RECTO	991364998 10,09
	CORTO	991364995 14,87			
	LEMÁN				991364989 16,29
	(320mm - 540mm)				
	LARGO	991364996 15,22			
	IMOLA			FORRES	991362072 14,08
	110	991364988 18,08			



SERIES DE PORCELANA UNISAN



EASY

LAVABO 60	560813132	54,00
LAVABO 55	560813131	49,00
LAVABO 50	560813133	48,00

PEDESTAL	560813120	41,00
----------	-----------	-------

TAZA RIMFLUSH S/DUAL	560813023	84,00
----------------------	-----------	-------

DEPÓSITO (A/I)	560813111	113,00
DEPÓSITO (A/L)	560813111	113,00

ASIENTO	560813231	49,00
ASIENTO SLOWCLOSE	560813232	64,00

BIDÉ	560813143	68,00
------	-----------	-------



WINNER

TAZA RIMFLUSH S/DUAL	561516001	121,00
----------------------	-----------	--------

DEPÓSITO A/I	561516002	146,00
DEPÓSITO A/S	561516003	146,00

ASIENTO SLIM AMORTIGUADO	561516004	73,00
--------------------------	-----------	-------

BIDÉ	561516005	105,00
------	-----------	--------

SERIES DE PORCELANA UNISAN



LOOK

TAZA S/DUAL compacto RIMFLUSH	561514534	160,00
TAZA S/DUAL compacto	561514021	150,00
DEPÓSITO A/INF	561514111	146,00
ASIENTO DUROPLAST	561514011	65,00
ASIENTO AMORTIGUADO	561514031	79,00
ASIENTO SLIM AMORTIGUADO *	561514241	79,00
110	991364981	4,88
BIDET	561514041	112,00
TAPA BIDET AMORTIGUADA	561514441	79,00



URB.Y PLUS

TAZA S/DUAL	561520510	234,00
DEPÓSITO A/	561520171	179,00
DEPÓSITO A/S	140173	179,00
ASIENTO DUROPLAST	561522011	66,00
ASIENTO AMORTIGUADO	561522031	82,00
ASIENTO SLIM AMORTIGUADO *	561520240	82,00
BIDÉ	561520511	214,00

COMPLEMENTOS WC

REF. €

REF. €



DESCARGA LOOK

560800302

38,80

DESCARGA EASY

560803302

38,80



GOMA OBTURADORA

560800170

2,20



PULSADOR DOBLE CORMO

560800011

12,00



ALIM. INF. LOOK

560800303

38,80

SERIES SUSPENDIDA

REF. €



SERIE LOOK



INODORO RIMFLUSH	<b>134034</b>	189,00
ASIENTO AMORTIGUADO	561514031	79,00
ASIENTO DUROPLAST	561514011	65,00
ASIENTO SLIM AMORTIGUADO *	561514241	79,00
BIDÉ SUSPENDIDO	561514555	215,00
TAPA BIDÉ AMORTIGUADA	561514441	79,00



SERIE URBY



INODORO 48cm	561520451	220,00
INODORO 52cm	561520455	235,00
ASIENTO AMORTIGUADO	561522031	82,00
ASIENTO DUROPLAST	561522011	66,00
ASIENTO SLIM AMORTIGUADO *	<b>2406104</b>	82,00
BIDÉ 52	561520450	216,00

SERIES TANQUE ALTO - ADOSADO A PARED

REF. €



EASY



WINNER

EASY T/A	560813103	96,00
TAPA EASY AMORTIGUADO	560813232	64,00
WINNER T/A	561517420	107,00
TAPA WINNER AMORTIGUADO	561516004	73,00

**CISTERNAS EMPOTRADAS**

REF. €



**SANFLUSH -  
PAREDES  
OBRA**

**560800422**  
**164,00 €**













**SANFIX -  
PAREDES  
LIGERAS**

**560800420**  
**284,00 €**



**SWITCH -  
INODORO  
CISTERNA  
ALTA**

**560800423**  
**143,00 €**

	<u>PLAN</u>	<u>ORANGE</u>	<u>EASY</u>
<b>NEGRO MATE</b>			
	<b>4001326</b> <b>68,00 €</b>	<b>4000326</b> <b>68,00 €</b>	
<b>CROMO SATINADO</b>			
	<b>560800020</b> <b>68,00 €</b>	<b>560800023</b> <b>68,00 €</b>	<b>560800017</b> <b>59,00 €</b>
<b>CROMO BRILLO</b>			
	<b>560800019</b> <b>68,00 €</b>	<b>560800022</b> <b>68,00 €</b>	<b>560800016</b> <b>59,00 €</b>
<b>BLANCO</b>			
	<b>560800018</b> <b>45,00 €</b>	<b>560800021</b> <b>45,00 €</b>	<b>560800015</b> <b>43,00 €</b>

ASIENTOS WC

Compatibilidad:

GRECIA



PORSAN (Venecia)  
ROCA (Lucerna / Victoria / Zoom)

991321010

29,95

SANGRÁ (Boreal)  
UNISAN (Cetus)

991321011

40,87

MANCHESTER



BELLAVISTA (New / Style)  
ROCA (Happening / Inspira / Meridian)

991321031

48,10

GALA (Bácara / Emm2 / Marina Vertical)  
UNISAN (Urby / Proget Gafort / Alfa Plus)

NAUTIC



MARINA (Gala)  
FIJACIÓN HORIZONTAL

991321050

39,52

OBYECT



ROCA (Dama Senso)

991321020

56,36

GALA (Smart)

DUCHAS HIGIÉNICAS



	REF.	€		REF.	€
 <p>MEZCALDOR EMPOTRADO AGUA FRÍA Y CALIENTE</p>	320170000	61,25	 <p>VÁLVULA CON SALIDA CISTERNA AGUA FRÍA</p>	320170001	31,25
				<p>REPUESTO FLEXO</p>	320170001



ACCESORIOS DE BAÑO

NIZA	REF.	€	CRETA	REF.	€
	120231001	26,05		120232001	35,10
	120231002	39,70		120232002	49,80
	120231003	28,70		120232003	44,70
	120231004	14,55		120232004	22,50
	120231005	29,30		120232005	12,00
	120231006	26,05		120100080	35,00
			PORTAROLLO + LLAVE CORTE		
			C-80		
			1/2 x 3/8		



**PLATOS DE DUCHA NATURE**

LARGO	ANCHO 70x		ANCHO 75x		ANCHO 80x		ANCHO 90x			
	REF.	€	REF.	€	REF.	€	REF.	€		
80 cm	5625+		+08070	211,00	+08075	-	+08080	229,00	-	-
90 cm	5625+		+09070	224,00	+09075	228,00	+09080	246,00	+09090	262,00
100 cm	5625+		+10070	248,00	+10075	258,00	+10080	266,00	+10090	280,00
110 cm	5625+		+11070	267,00	+11075	270,00	+11080	280,00	+11090	304,00
120 cm	5625+		+12070	286,00	+12075	289,00	+12080	307,00	+12090	326,00
130 cm	5625+		+13070	304,00	+13075	323,00	+13080	321,00	+13090	339,00
140 cm	5625+		+14070	312,00	+14075	323,00	+14080	336,00	+14090	349,00
150 cm	5625+		+15070	332,00	+15075	351,00	+15080	344,00	+15090	365,00
160 cm	5625+		+16070	344,00	+16075	351,00	+16080	359,00	+16090	376,00
170 cm	5625+		+17070	365,00	+17075	390,00	+17080	391,00	+17090	423,00
180 cm	5625+		+18070	384,00	+18075	390,00	+18080	405,00	+18090	442,00
190 cm	5625+		+19070	411,00	+19075	433,00	+19080	434,00	+19090	492,00
200 cm	5625+		+20070	421,00	+20075	433,00	+20080	454,00	+20090	514,00



**INCLUYE  
VÁLVULA**



**PLATOS DE DUCHA HERMES**

LARGO	ANCHO 70x		ANCHO 80x		ANCHO 90x		ANCHO 100x			
	REF.	€	REF.	€	REF.	€	REF.	€		
100 cm	5624+		+10070	248,00	+10080	266,00	-	281,00	-	301,00
110 cm	5624+		+11070	-	+11080	-	-	-	-	-
120 cm	5624+		+12070	286,00	+12080	307,00	-	326,00	-	351,00
130 cm	5624+		+13070	-	+13080	-	-	-	-	-
140 cm	5624+		+14070	312,00	+14080	336,00	-	350,00	-	388,00
150 cm	5624+		+15070	332,00	+15080	343,00	-	365,00	-	405,00
160 cm	5624+		+16070	343,00	+16080	359,00	-	376,00	-	422,00
170 cm	5624+		+17070	365,00	+17080	391,00	-	423,00	-	479,00
180 cm	5624+		+18070	384,00	+18080	405,00	-	442,00	-	506,00
190 cm	5624+		+19070	-	+19080	-	-	-	-	-
200 cm	5624+		+20070	421,00	+20080	454,00	-	514,00	-	546,00



**INCLUYE  
VÁLVULA**



**COMPLEMENTOS PLATOS DE DUCHA OBRA**

**MOD. GDANSK**



**DIMENSIONES:**

- ALTURA MIN: 75 mm
- ALTURA MAX: 115 mm
- ANCHO: 118 mm
- ANCHO HUECO: 80 mm
- LITROS / MINUTO: 56 l/min - EN274
- DIÁMETRO SALIDA: Ø 50
- RESISTENCIA REJILLA: 300 Kgs.
- MATERIAL: 100% Fabricado INOX. AISI 304

**DISEÑO REJILLA GDANSK**



REFERENCIA	MEDIDA	PVP
991324061	600 mm	172,66
991324071	700 mm	182,31
991324081	800 mm	192,06
991324091	900 mm	201,89

**LÁMINA GEOTEXTIL IMPERMEABILIZANTE**



300 x 100 (3m <sup>2</sup> )	991329021	42,12
------------------------------	-----------	-------

# ¿Por qué Vaillant?

Soluciones con la máxima eficiencia energética



Porque  **Vaillant** piensa en futuro.

## MAMPARAS



## FADO

ANCHURA (F) cm	ANCHURA (L) cm	VIDRIO TRANSPARENTE 6 mm			
		PLATA ALTO BRILLO		NEGRO	
		CÓDIGO	PVP/€	CÓDIGO	PVP/€
FD - 90	90 - 91	121000101	295,00	20069013	325,00
FD - 100	100 - 101	121000102	306,00	20061013	337,00
FD - 110	110 - 111	121000103	320,00	20061113	351,00
FD - 120	120 - 121	121000104	332,00	20061213	362,00



### SALMA SA - 320

MEDIDAS (LI + LD) cm	ANCHURA (mm)	TRANSPARENTE		SATINADO BOLD	
		PLATA ALTO BRILLO		PLATA ALTO BRILLO	
		CÓDIGO	PVP/€	CÓDIGO	PVP/€
77,5-79x77,5-79	401	22453011	544,00	22453012	592,00
87,5-89x87,5-89	472	22453021	568,00	22453022	616,00
87,5-89x67,5-69	407	22453031	544,00	22453032	592,00
97,5-99x67,5-69	449	22453041	551,00	22453042	604,00
97,5-99x77,5-79	477	22453051	563,00	22453052	616,00
117,5-119x67,5-69	537	22453061	574,00	22453062	640,00
117,5-119x77,5-79	560	22453071	587,00	22453072	651,00
117,5-119x87,5-89	587	22453081	598,00	22453082	663,00
137,5-139x67,5-69	628	22453091	609,00	22453092	670,00
137,5-139x77,5-79	649	22453101	621,00	22453102	681,00

\* En perfilera color negro sumar 20€ a la transparente alto brillo



### SPG - 320

MEDIDAS (LI + LD) cm	ANCHURA (mm)	TRANSPARENTE		SATINADO BOLD	
		PLATA ALTO BRILLO		PLATA ALTO BRILLO	
		CÓDIGO	PVP/€	CÓDIGO	PVP/€
77-80x77-80	42	2426011	554,00	24280114	573,00
97-100x67-80	46	2426041	561,00	24280414	581,00
77-100x77-80	49	2426051	568,00	24280514	587,00
117-120x67-80	55	2426061	575,00	24280614	594,00
117-120x77-80	57	2426071	583,00	24280714	601,00
137-140x67-70	64	2426081	671,00	24280814	690,00
137-140x77-80	66	2426091	676,00	24280914	694,00



## SALMA SA - 310

ANCHURA (F) cm	APERTURA (mm)	TRANSPARENTE		SATINADO BOLD	
		PLATA ALTO BRILLO		PLATA ALTO BRILLO	
		CÓDIGO	PVP/€	CÓDIGO	PVP/€
115-118	469	121000001	383,00	22451052	417,00
118-121	484	121000002	390,00	22451062	425,00
125-128	519	121000003	396,00	22451072	434,00
128-131	534	121000004	404,00	22451082	442,00
135-138	569	121000005	411,00	22451092	450,00
138-141	584	121000006	418,00	22451102	459,00
145-148	619	121000007	425,00	22451112	467,00
148-151	634	121000008	433,00	22451122	475,00
155-158	669	121000009	440,00	22451132	483,00
158-161	684	121000010	446,00	22451142	492,00
165-168	719	121000011	453,00	22451152	500,00
168-171	734	121000012	461,00	22451162	508,00
175-178	769	121000013	468,00	22451172	516,00

\* En perfilera color negro sumar 20€ a la transparente alto brillo



## SPG - 310

ANCHURA (F) cm	APERTURA (mm)	TRANSPARENTE		SATINADO BOLD	
		PLATA ALTO BRILLO		PLATA ALTO BRILLO	
		CÓDIGO	PVP/€	CÓDIGO	PVP/€
114-120	46	2416201	424,00	24182014	444,00
120-126	49	2416261	428,00	24182614	448,00
126-132	52	2416321	431,00	24183214	450,00
132-138	55	2416381	436,00	24183814	455,00
138-144	58	2416441	440,00	24184414	457,00
144-150	61	2416501	445,00	24185014	464,00
150-156	64	2416561	454,00	24185614	472,00
156-162	67	2416621	461,00	24186214	478,00
162-168	7	2416681	468,00	24186814	486,00
168-174	73	2416741	483,00	24187414	502,00
174-180	76	2416801	504,00	24188014	524,00



## SALMA

## SA-310+LDF-SA

ANCHURA (F) cm	APERTURA (mm)	ANCHURA FIJO (L) cm LDF-SA	TRANSPARENT			SATINADO BOLD		
			PLATA ALTO BRILLO			PLATA ALTO BRILLO		
			CÓDIGO		PVP/€	CÓDIGO		PVP/€
			FRONTAL	LATERAL		FRONTAL	LATERAL	
115-118	469	67-69	22451051	22454011	614,00	22451052	22454012	472,00
		77-79		22454021	626,00		22454022	684,00
118-121	484	67-69	22451061	22454011	621,00	22451062	22454012	680,00
		77-79		22454021	633,00		22454022	692,00
125-128	519	67-69	22451071	22454011	627,00	22451072	22454012	688,00
		77-79		22454021	640,00		22454022	701,00
128-131	534	67-69	22451081	22454011	634,00	22451082	22454012	697,00
		77-79		22454021	647,00		22454022	709,00
135-138	569	67-69	22451091	22454011	642,00	22451092	22454012	705,00
		77-79		22454021	654,00		22454022	717,00
138-141	584	67-69	22451101	22454011	649,00	22451102	22454012	713,00
		77-79		22454021	661,00		22454022	726,00
145-148	619	67-69	22451111	22454011	656,00	22451112	22454012	721,00
		77-79		22454021	669,00		22454022	734,00
148-151	634	67-69	22451121	22454011	663,00	22451122	22454012	730,00
		77-79		22454021	676,00		22454022	742,00
155-158	669	67-69	22451131	22454011	671,00	22451132	22454012	741,00
		77-79		22454021	683,00		22454022	750,00
158-161	684	67-69	22451141	22454011	677,00	22451142	22454012	742,00
		77-79		22454021	689,00		22454022	759,00
165-168	719	67-69	22451151	22454011	684,00	22451152	22454012	755,00
		77-79		22454021	697,00		22454022	767,00
168-171	734	67-69	22451161	22454011	691,00	22451162	22454012	763,00
		77-79		22454021	703,00		22454022	775,00
175-178	769	67-69	22451171	22454011	698,00	22451172	22454012	771,00
		77-79		22454021	711,00		22454022	783,00



**SRING**  
**SPG-310+LDF-SPG**

ANCHURA (F) cm	APERTURA (mm)	ANCHURA FIJO (L) cm LDF-SA	TRANSPARENTE			SATINADO BOLD		
			PLATA ALTO BRILLO			PLATA ALTO BRILLO		
			CÓDIGO		PVP/€	CÓDIGO		PVP/€
			FRONTAL	LATERAL		FRONTAL	LATERAL	
111-114	46	67-70	2416201	200214170	617,00	24182014	20024172	654,00
		77-80	2416201	200214180	626,00	24182014	20024182	664,00
117-120	49	67-70	2416261	200214170	621,00	24182614	20024172	658,00
		77-80	2416261	200214180	631,00	24182614	20024182	669,00
123-126	52	67-70	2416361	200214170	623,00	24183214	20024172	659,00
		77-80	2416361	200214180	632,00	24183214	20024182	671,00
129-132	55	67-70	2546381	200214170	628,00	24183814	20024172	666,00
		77-80	2546381	200214180	638,00	24183814	20024182	676,00
135-138	58	67-70	2416441	200214170	632,00	24184414	20024172	667,00
		77-80	2416441	200214180	642,00	24184414	20024182	678,00
141-144	61	67-70	2416501	200214170	638,00	24185014	20024172	673,00
		77-80	2416501	200214180	647,00	24185014	20024182	684,00
147-150	64	67-70	2416561	200214170	647,00	24185614	20024172	681,00
		77-80	2416561	200214180	656,00	24185614	20024182	692,00
153-156	67	67-70	2416621	200214170	653,00	24186214	20024172	687,00
		77-80	2416621	200214180	662,00	24186214	20024182	699,00
159-162	70	67-70	2416681	200214170	661,00	24186814	20024172	696,00
		77-80	2416681	200214180	670,00	24186814	20024182	707,00
165-168	73	67-70	2416741	200214170	676,00	24187414	20024172	711,00
		77-80	2416741	200214180	685,00	24187414	20024182	722,00
171-174	76	67-70	2416801	200214170	696,00	24188014	20024172	733,00
		77-80	2416801	200214180	706,00	24188014	20024182	744,00



# Solución C-80

Portarrollo con llave de escuadra



**DUCHAS Y COMPLEMENTOS**

BLAUTHERM



MONOMANDO  
EXTENSIBLE

400509344
466,00 €



MONOMANDO EXTENSIBLE  
ROCIADOR CUADRADO

400509345
445,00 €

**EMPOTRADAS (BLAUTHERM)**



Todo en 1 caja  
KIT EMPOTRADO  
CROMO

400509706
300,00 €



Todo en 1 caja  
KIT EMPOTRADO  
NEGRO



400509707
450,00 €

DUCHAS Y COMPLEMENTOS



COLUMNA DUCHA  
KORAL EXTENSIBLE  
NEGRO

402168200
537,20



COLUMNA DUCHA  
KORAL EXTENSIBLE  
CROMO

402168100
378,31



COLUMNA DUCHA SIN  
GRIFERIA

402165215
237,18

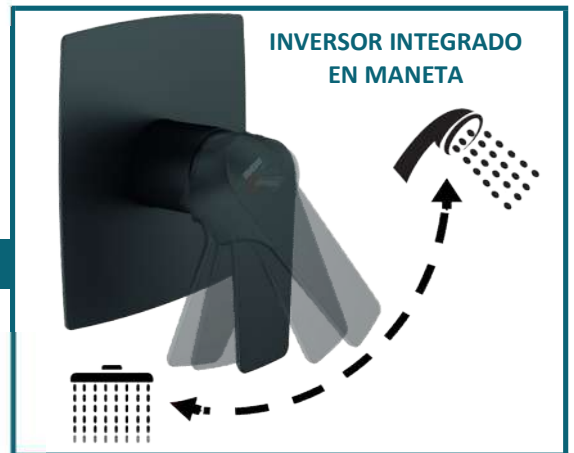

INVERSOR INTEGRADO  
EN MANETA

EMPOTRADAS



CROMO



NEGRO

CROMO	402168108	128,90
-------	-----------	--------

NEGRO	402168206	174,30
-------	-----------	--------

## DUCHAS Y COMPLEMENTOS

### BARRA DUCHA



400803742

42,67 €

### MANERALES



SKARA

400803706

12,33 €



AQUA 1.0

400803710

8,33 €



AQUA 3.0

400803715

10,33 €



ECO

400803703

4,00 €

### ROCIADORES



ABS ROTULA

400803406

4,10 €



AQUA

400803409

12,33 €



ACERO 20cm

400803440

26,67 €

### BRAZOS



1/2 x 30 cm

400803301

9,33 €



TECHO

400803308

9,67 €



INCLINADO

400803310

10,00 €

### SOPORTES



CODO TOMA

400803631

16,67 €



SOPORTE TOMA

400803630

16,00 €



ERGOS

400803626

7,53 €



NATURA

400803621

3,20 €



Almacén de Fontanería

**Regístrate en nuestro ecommerce**

Descúbrelo en  
**tienda.suministroscoplasa.es**

Podrás consultar tus documentos  
**Ofertas - Pedidos - Albaranes - Facturas**



También pedir  
**materiales 24h**



*Fácil, rápido y GRATIS*

Captura con tu móvil este código QR  
para acceder a un vídeo explicativo.

**CONJUNTO CHEAP**



3 cajones  
Muebles 80cm + Lavabo

*\*No incluye grifería*

NETO

**121200503** **255,00 €**

**CONJUNTO CHEAP  
SUSPENDIDO**



2 cajones  
Muebles 60cm + Lavabo

*\*No incluye grifería*

NETO

**121200501** **175,00 €**

Mueble 80cm + lavabo

NETO

**121200502** **195,00 €**



ESPEJO REVERSIBLE 80.60

120207049  
39,00



APLIQUE LED

120207643  
34,00



**CONJUNTO  
VITALE SUSPENDIDO**

**50cm**  
**2 cajones**  
**F35 (fondo**  
**reducido)**

**Mueble +**  
**Lavabo +**  
**Espejo liso**

**\*No incluye**  
**grifería ni foco**

**333,00**

-  BL19  
Blanco Nature
-  RO6  
Beige Nature
-  GR37  
Gris Nature
-  BL1B  
Blanco Brillo
-  MA13M  
Fumo Mate

**Mueble**  
**+ Lavabo**  
**+ Espejo liso**  
**+ Aplique Led**  
**80 cm**

**\* No incluye grifería**

**549,00**



-  GR21
-  NO14
-  BL1B
-  GR16B
-  GR35B
-  RO14
-  RO13
-  AZ6B

**CONJUNTO STREET  
SUSPENDIDO**



NEW FLY

TITANIUM



TOOL FREE

400557023 68,44

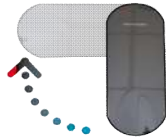

APERTURA EN FRIO



TOOL FREE

400501801 48,00



TOOL FREE

400557031 66,40



TOOL FREE

400501803 49,80



400557080 122,20



400501808 80,50









400557050 142,20











400501805 96,20

## TEMPORIZADOS GENEVRE

	REF.	€		REF.	€
			LAVABO REPISA		
	401471160	50,81			
			LAVABO PARED		
	401471037	39,70			
			URINARIO		
	401471185	38,57			
			LAVABO IPSON		
	401471030	60,60			
			DUCHA EMPOTRAR 1 AGUA		
	401471173	63,05			
			TUBO URINARIO		
	401471018	11,02			

## TEMPORIZADOS PRESTO

			LAVABO		
			Grifo	401488300	78,60
			Montura	401489100	47,70
			GRIFO URINARIO		
			Grifo	401488200	71,20
			Tubo	401488100	20,20
			Montura	401489102	47,70
			GRIFO FRONTAL		
				401484100	66,40
			FLUXOR WC		
			Goma	401489200	83,70
			Enchufe Wc	401489202	4,60
			Tubo Flexor Wc	401489201	37,50
			MANETA	401481200	33,40
			PISTON	401489847	17,80
			EMPOTRADO DUCHA		
				401488400	78,80
			CAÑO LAVABO GIRATORIO		
				401489302	70,40

MONOMANDOS SERIE KORAL

REF. €



**MEDIO ALTO**  
402168107 154,26

**LAVABO**  
402168101 94,27



**MEDIO ALTO**  
402168205 216,00

**LAVABO**  
402168201 132,00



**BIDET**  
402168102 87,54



**BIDET**  
402168202 122,60



**BAÑO-DUCHA**  
402168103 162,22



**BAÑO-DUCHA**  
402168203 227,10



**DUCHA**  
402168104 137,13



**DUCHA**  
402168204 192,00



**EMPOTRADO 2 VÍAS**  
402168108 128,90

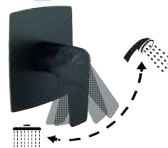

**TERMOSTÁTICA DUCHA**  
402167104 166,51



**EMPOTRADO 2 VÍAS**  
402168206 174,30

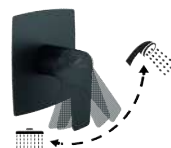

**TERMOSTÁTICA BAÑO**  
402167103 212,42



SERIE OSLO

SERIE OSLO NEGRO

	REF.	€		REF.	€
	MEDIO ALTO 402165134	104,68		MEDIO ALTO 402165235	215,48
	LAVABO 402165130	104,68		LAVABO 402165236	151,81
	BIDET 402165140	102,23		BIDET 402165237	148,14
	DUCHA 402165110	142,63		DUCHA 402165239	206,91
	BAÑO-DUCHA 402165100	163,45		BAÑO-DUCHA 402165238	206,91

SERIE BASIK

SERIE K8

	REF.	€
	LAVABO 402169130	55,29
	BIDET 402169140	57,10
	BAÑO-DUCHA 402169100	97,42
	DUCHA 402169110	79,95
	EMPOTRADO 402169116	83,06

	REF.	€
	LAVABO MEDIO ALTO 402133402	59,38
	LAVABO 402133401	51,43
	BIDET 402133403	50,81
	BAÑO-DUCHA 402133405	91,83
	DUCHA 402133408	71,01
	EMPOTRADO 2 VÍAS 402133116	116,36
	EMPOTRADO 1 VÍAS 402133115	93,08

GRIFERÍA CONVENCIONAL

	REF.	€		REF.	€
 <p>11 cm</p>	402068195	68,56	 <p>15 cm</p>	402068190	68,56
 <p>PARED</p>	402010060	33,06	 <p>REPISA</p>	402010090	44,08
 <p>REPISA</p>	402010070	33,67		402068093	37,95



	REF.	€		REF.	€	
 <p>12 o 17 cm</p>	(12) 400450703	36,50	 <p>LLAVE DE PASO</p>	15	400470076	32,75
	(17) 400450708	43,05		18	400470079	54,06
				22	400470074	54,06
				1/2	400470072	38,75
				3/4	400470073	54,06

## FREGADEROS FIBRA

**SETH** 660 x 510



**BLANCO**  
340800022  
228,00 €

**GRANITO**  
340800023  
330,00 €

**PEGASO** 863 x 473



**BLANCO**  
340800006  
218,00 €

**GRANITO**  
340800056  
321,00 €

**TROYA** 450 x 450



**BLANCO**  
340800015  
152,00 €

**GRANITO**  
340800065  
222,00 €

**ORION** 822 x 496



**BLANCO**  
340800012  
209,00 €

**GRANITO**  
340800062  
310,00 €

**DIANA** 910 x 510



**BLANCO**  
340800005  
328,00 €

**GRANITO**  
340800055  
424,00 €

**ATON** 855 x 510



**BLANCO**  
340800007  
220,00 €

**GRANITO**  
340800057  
321,00 €

FREGADEROS SÍLICE QUARZ

REF. €

GARBI B/E (54,6x43,6cm)



991396003 289,00

COLORES SILK (BRILLO)

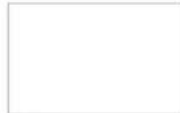

BLANCO



PLOMO



NEGRO



METALIZADO



SOMBRA



SILVER



CEMENTO



ARENA



SEDA

- MEDIDAS DE ENCASTRE -

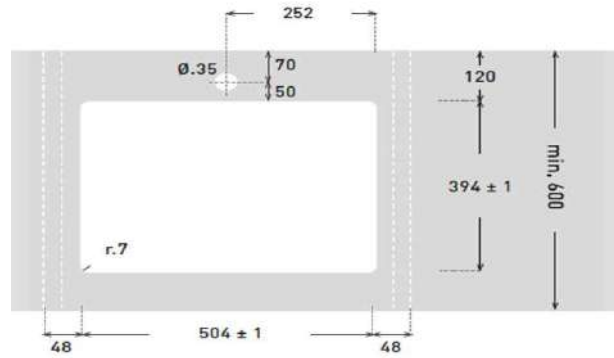

VICTORIA S/E (85x49,6xm)



991396002 249,00

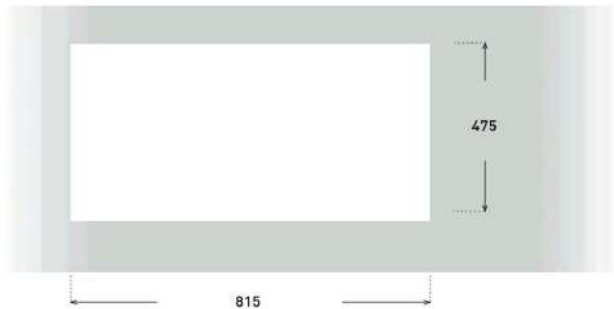

SOLUCION S/E (91,5x51,5cm)



991396001 289,00

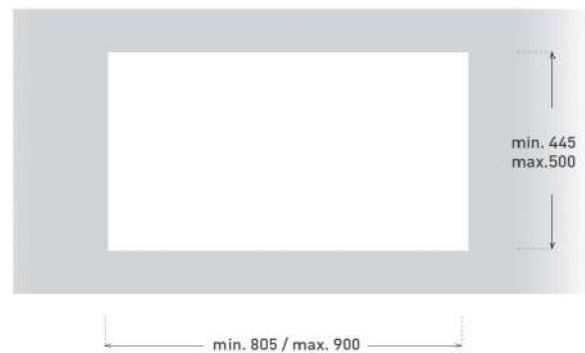



**FREGADEROS GRANITO**

REF. €



340725646 **AMSTERDAM 50 BL** 299,00  
 340724646 **AMSTERDAM 40 BL** 289,00

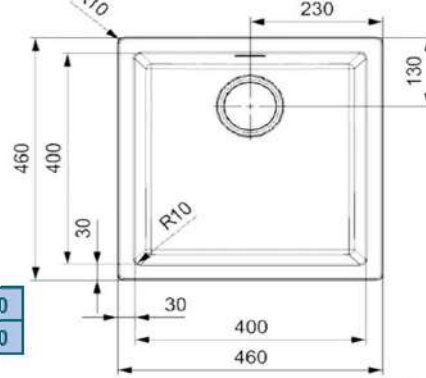
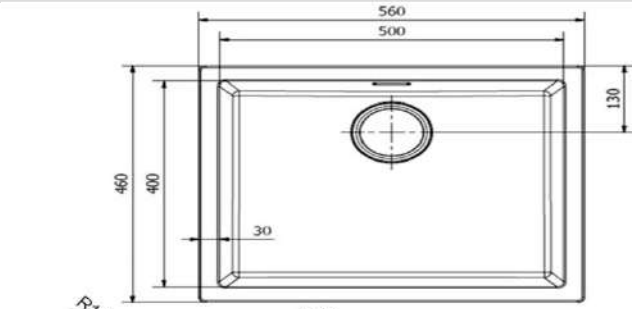

-  Blanco Puro
-  Crema
-  Gris Plateado
-  Negro Plateado



**AMSTERDAM 72** 405,00

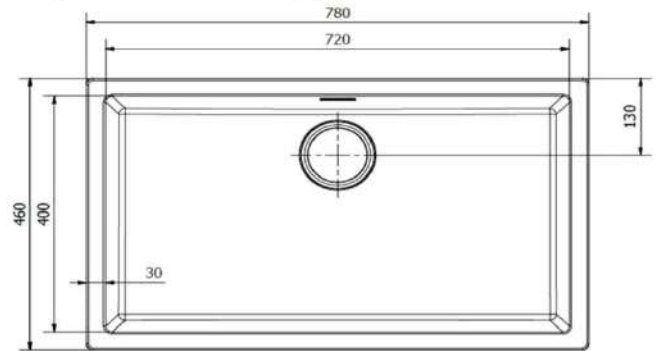



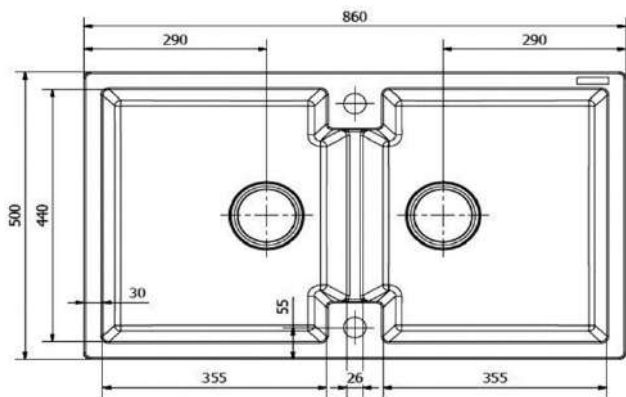



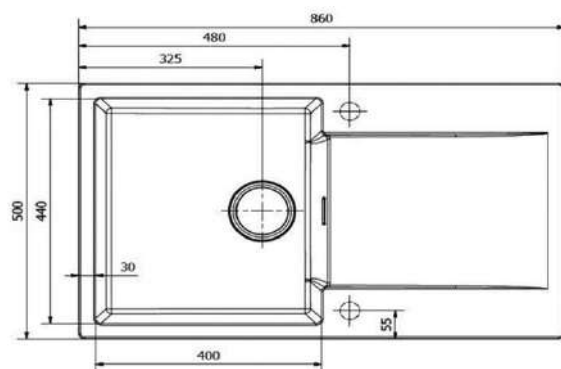

**AMSTERDAN 20** 405,00

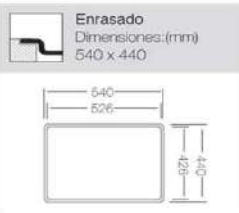
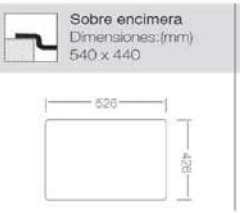
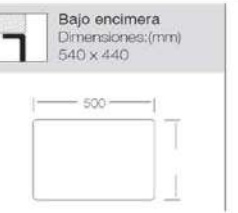
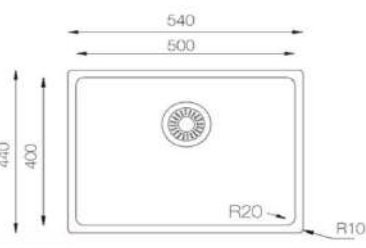

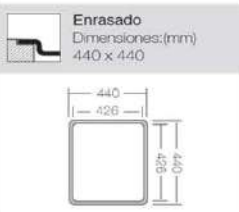
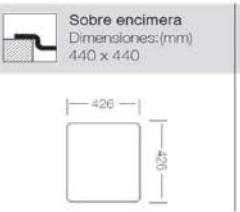
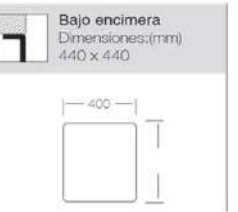
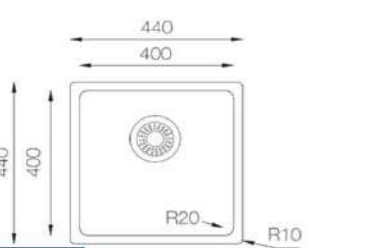
**AMSTERDAM 10** 365,00

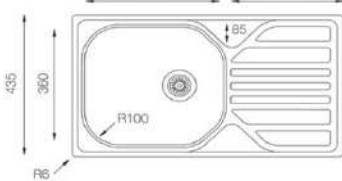

**FREGADEROS INOX**

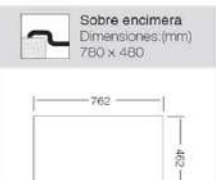
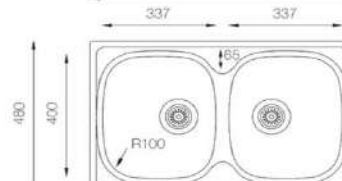
	REF.	€		REF.	€
			 <p>Enrasado Dimensiones:(mm) 540 x 440</p>	 <p>Sobre encimera Dimensiones:(mm) 526 x 440</p>	 <p>Bajo encimera Dimensiones:(mm) 540 x 440</p>
			 <p>Mueble soporte: 600mm Profundidad: 200mm Medidas cubeta: 500x400mm Medidas exteriores: 540x440mm Espesor chapa: 1mm Acabado: Pulido</p>		
<p><b>LUXORS/E y B/E(54x44cm)</b></p>	<p><b>340725040</b></p>	<p><b>185,00</b></p>			
			 <p>Enrasado Dimensiones:(mm) 440 x 440</p>	 <p>Sobre encimera Dimensiones:(mm) 440 x 440</p>	 <p>Bajo encimera Dimensiones:(mm) 440 x 440</p>
			 <p>Mueble soporte: 450mm Profundidad: 200mm Medidas cubeta: 400x400mm Medidas exteriores: 440x440mm Espesor chapa: 1mm Acabado: Pulido</p>		
<p><b>LUXOR S/E y B/E(44x44cm)</b></p>	<p><b>340724040</b></p>	<p><b>167,00</b></p>			
			 <p>Ref. 370760 con orificio grifo</p>	 <p>Ref. 370765 con orificio grifo</p>	 <p>Sobre encimera Dimensiones:(mm) 760 x 435</p>
			 <p>Mueble soporte: 450mm Profundidad: 165mm Medidas cubeta: 390x360mm Medidas exteriores: 760x435mm Espesor chapa: 0,60mm Acabado: Satinado</p>		
<p><b>GENOVA S/E (78x48cm)</b></p>	<p><b>340770781</b></p>	<p><b>110,00</b></p>			
			<p>Ref. 380780 - con orificio grifo</p>	<p>Ref. 380781 - SIN orificio grifo</p>	 <p>Sobre encimera Dimensiones:(mm) 780 x 480</p>
			 <p>Mueble soporte: 800mm Profundidad: 140/140mm Medidas cubeta: 337x400mm 337x400mm Medidas exteriores: 780x480mm Espesor chapa: 0,60mm Acabado: Satinado</p>		
<p><b>BRESCIA S/E (78x48cm)</b></p>	<p><b>340780780</b></p>	<p><b>126,00</b></p>			

**MONOMANDOS FREGADERO**

	REF.	€		REF.	€	
<p>(11cm) CAÑO 30 cm</p> <p><b>K8</b></p>  <p>(15cm) CAÑO 30 cm</p> <p>(15cm) CAÑO 21 cm</p>	402133460	103,15	<b>BASIK</b>	402169192	90,49	
				FREGADERO CAÑO MURAL 15 cm		
	402133470	104,19				
	402133475	87,54				
<b>K8</b>	402133440	65,58	<b>BASIK</b>	402169200	56,08	
				FREGADERO CAÑO HORIZONTAL		
<b>K8</b>	402133499	153,65				
		extraíble	<b>KORAL</b>			
<b>K8</b>	402133599	127,94		FREGADERO	402168105	149,97
		extraíble				
<b>K8</b>	402133456	99,66	<b>BASIK</b>	402169203	80,84	
				FREGADERO CAÑO CONFORMADO		

**MONOMANDOS FREGADERO**

	REF.	€		REF.	€
 <p><b>TAU MONOMANDO FREGADERO CAÑO FLEXIBLE CROMO-NEGRO</b></p>	<b>402065219</b>	<b>241,05</b>	 <p><b>COLUMNA PRELAVADO</b></p>	<b>401471159</b>	<b>402,58</b>
 <p><b>TAU MONOMANDO NEGRO</b></p>	<b>402121301</b>	<b>178,13</b>	 <p><b>VULCANO 6999 MEDICAL</b></p>	<b>400526999</b>	<b>69,87</b>
 <p><b>OSMOSIS CAÑO FLEXIBLE</b></p>	<b>400598988</b>	<b>334,56</b>	 <p><b>TITANIUM 1806</b></p>	<b>400501806</b>	<b>73,23</b>
 <p><b>OSMOSIS 3 VÍAS</b></p>	<b>402065702</b>	<b>228,94</b>	 <p><b>TITANIUM 1836</b></p>	<b>400501836</b>	<b>69,87</b>
<p><b>NEGRO</b></p>	<b>402065703</b>	<b>337,78</b>			
<p><b>INOX</b></p>	<b>402065704</b>	<b>358,04</b>			



CONSULTA NUESTRA

GAMA DE

ELECTRODOMÉSTICOS





Almacén de Fontanería

**PISCINAS - FOSAS Y DEPURADORAS -  
TRATAMIENTOS DE AGUA - AEROTERMIA -  
CALEFACCIÓN - GRIFERÍAS - MATERIAL  
CONTRAINCENDIOS - GAS -  
DESCALCIFICADORES - SANITARIOS -  
ACCESORIOS PARA BAÑOS PÚBLICOS -  
BOMBAS DE AGUA - VALVULERÍA -  
TUBERIAS - VENTILACIÓN - DEPÓSITOS -  
MÁQUINAS - HERRAMIENTAS - TERMOS -  
ACUMULADORES - AIRE ACONDICIONADO**

*Siempre Cerca de tí*

**ALMACÉN**

C/ JUAN RAMÓN JIMÉNEZ, 11-13  
46930 QUART DE POBLET  
TEL. 961548962

[quart@suministroscoplasa.com](mailto:quart@suministroscoplasa.com)

**ALMACÉN - OFICINAS  
SHOWROOM**

C/ DOMINGO GÓMEZ, 23  
46025 VALENCIA  
TEL. OFICINAS: 963471573  
TEL. ALMACÉN: 963473527

[valencia@suministroscoplasa.com](mailto:valencia@suministroscoplasa.com)

[www.suministroscoplasa.com](http://www.suministroscoplasa.com)



**ALMACÉN**

C/ TANDA XICA, 29 - NAVE 2  
P.I. CAMÍ DE LA VILA  
46800 XÁTIVA  
TEL. 961712387

[xativa@suministroscoplasa.com](mailto:xativa@suministroscoplasa.com)

**14ª Feria del  
Instalador**